

**ETREL**

**ELECTRIC VEHICLE CHARGING  
STATION**

**ETREL INCH**

**ELECTRICAL INSTALLATION  
SPECIFICS**

Document version: 1.7

Document date: 11. 11. 2021



# TABLE OF CONTENTS

<b>1</b>	<b>BASIC DESCRIPTION</b> .....	<b>1</b>
	About this Document.....	1
	Site Preparation .....	1
	Permits .....	2
	Location.....	2
	Content, Optional and Extra Equipment.....	4
	Tools.....	5
<b>2</b>	<b>PRODUCT DESCRIPTION</b> .....	<b>6</b>
	Components Overview .....	7
	Base Specifications.....	7
	Grid Connection .....	8
	Connection to the Station Operator's Communication Network ..	8
	Circuit Diagram .....	10
	External Signal.....	11
	Digital Inputs and Digital Outputs.....	11
<b>3</b>	<b>CABLE CROSS-SECTION SELECTION</b> .....	<b>12</b>
	Minimum Cables Cross-Section .....	12
	Other Consumption or Production of Electricity at the Location ....	15
	Load Guard.....	15
<b>4</b>	<b>DIMENSIONING OF A CLUSTER</b> .....	<b>17</b>
	Cabling Route for the Connection of Multiple Charging Stations....	18
	Cluster Cables Cross-Section.....	20
	Examples of Connection .....	27
<b>5</b>	<b>CONNECTING CHARGING STATION</b> .....	<b>33</b>
	Insertion of Cables Through the Installation Pipe .....	33
	Preparation of Cables .....	34
	Mounting of the Charging Station and Installation of Cables.....	40
<b>6</b>	<b>ELECTRICAL MEASUREMENTS</b> .....	<b>50</b>
	Earthing Conductor Continuity test .....	50
	Insulation Resistance Measurement .....	51
	RCD Test.....	52
	Measurements of the Effectiveness of Protection Against Electric Shock.....	53
	Earth Electrode Resistance Measurement .....	54
<b>7</b>	<b>OPERATION AND CHARGING PROCEDURE</b> .....	<b>58</b>
	First Power up .....	58
	Setting of Maximal Charging Current .....	59
	First Charging Session .....	59
	Charging Procedure .....	59
	Check Status of the Charging Station.....	63
	Stop the Charging Session.....	63
<b>8</b>	<b>CONTACT INFORMATION</b> .....	<b>65</b>

# 1

## **BASIC DESCRIPTION**

### **ABOUT THIS DOCUMENT**

The safety and installation instructions "Quick Start Guide" that comes with the charging station includes quick installation procedure should be read first:

- *Etrel\_INCH\_QuickStartGuide.pdf*
- *Etrel\_INCH\_QuickStartGuide\_Figures.pdf*

The document in front of you contains information on the physical layout of the INCH charging station. As it is necessary to think in advance about the accompanying electrical works, basic information about them is also included.

More information about electrical works is available in the document "Electrical Installation Specifics":

- *Etrel\_INCH\_Electrical\_Installation\_Specifics.pdf*

All the documents are available in the installation manuals section, accessible from the INCH product page, at the web page <https://etrel.com/charging-solutions/inch/>

### **SITE PREPARATION**

#### **CONFIRMATION OF READINESS**

Before carrying out the installation, the client must confirm his readiness usually with a statement, that all the requirements for the preparation of the location and additional image material are met, which allows remote checking of compliance.

#### **ACCESS TO INSTALLATION SITE**

An access to the location should be made possible to service vehicle for installation and servicing of charging stations.

#### **SUPPORT DURING INSTALLATION**

The responsible staff for both electricity installations and IT communications should be present on the location or available for immediate remote support.

#### **EXTERNAL FACTORS**

Installation cannot be carried out in the event of extremely rainy or snowy weather or other external factors that can prevent safe mounting, installation, and commissioning of charging stations. The charging station installation should be cancelled under such circumstances.

### **INSTRUCTIONS VALIDITY**

The client shall check with manufacturer for the latest valid version of instructions before the preparation of location(s) for installation of charging stations. Please make an inquiry with the point of contact at the retailer or manufacturer's support of your charging station to request the latest instructions version when necessary.

## **PERMITS**

### **LOCATION AND BUILDING PERMIT**

The charging station is a simple object and there is usually no need to acquire any building permits for its installation. If the installation site is a part of municipal property, consent of the relevant authorities must be acquired before the charging station can be installed. Installations must be performed in accordance with possible additional requirements of the national regulation.

### **CONNECTION TO THE GRID**

The charging station must be connected to the low-voltage electricity distribution network. No special permit is required to connect to an existing network behind the metering point. The connection can be done by any authorised electrician. Installations must be performed in accordance with possible additional requirements of the national regulation.

### **PARKING PERMITS**

Parking must be possible in the direct vicinity of the station and permitted by the operator or owner of the parking area. Estimated time for a full charge depends on the current state of the battery and the vehicle's charging power. Charging procedure usually takes between 30 minutes and up to 8 hours. Installations must be performed in accordance with possible additional requirements of the national regulation.

## **LOCATION**

Charging station should be installed in the vicinity of the parking spot that will be used to park and charge electric vehicles. They can have charging socket located in various positions. Consequently, cable length to connect EV and charging station is important.

The sufficient cable length to easily connect the electric vehicle with the charging station, regardless of where the EV's charging socket is located, should be between 3 and 7 m and depends on the charging station location in comparison to parking spot. Shorter length cables are recommended as they are easier to handle.

Make sure that in a typical connection scenario there are no obstructions in the way of the charging cable. When in use, the charging cable should be laid so that it will not be stepped on, tripped over, or otherwise subjected to damage or stress.

Charging station should be mounted so that the plug of the charging station is located approximately 120 cm above the ground. This height enables averagely high user the easiest operation of charging station and connection of charging cable. It also provides best view and operation of the LCD screen.

Etrel INCH charging station and its components (cable, casing, LCD screen...) are developed to be installed in the outside area meaning that charging station is resilient to the external actors (UV rays, rain, snow, cold etc.). Installing it in the closed-up area, for example in garage, will prolong the lifespan of the charging station and keep it in a pristine condition for longer.

## **THERE IS NO FUNCTION OF VENTILATION IMPLEMENTED IN THE CHARGING STATION.**

Location of the charging station must meet the following criteria:

- The charging station must not be submersed in water or any other fluid and should not be installed in flood risk areas.
- The operational temperature of the charging station is between - 25°C and + 65°C.

For locations where the charging station will be exposed to direct sunlight and high ambient temperatures during the day, it is recommended to install protection from direct sunlight, otherwise the temperature inside the station may exceed 65°C.

- Charging station must not be installed in explosion hazardous areas (EX zone)

### **REQUIRED SPACE**

Charging station can be mounted on the wall or installed on the mounting pole. Mounting plate for installation on the wall is supplied with every INCH and mounting pole is additional component that can be ordered.

Basic installation of the charging station's mounting pole without arches requires an excavation of minimal dimensions of 500 mm x 420 mm (floor plan) and depth of 600 mm. If the charging station is installed together with two safety arches, dimensions of the required dimensions are approximately 750 mm x 500 mm. Please find more information in document Etrel INCH Physical Installation, in chapter Construction Works.

### CHARGING STATION DIMENSIONS

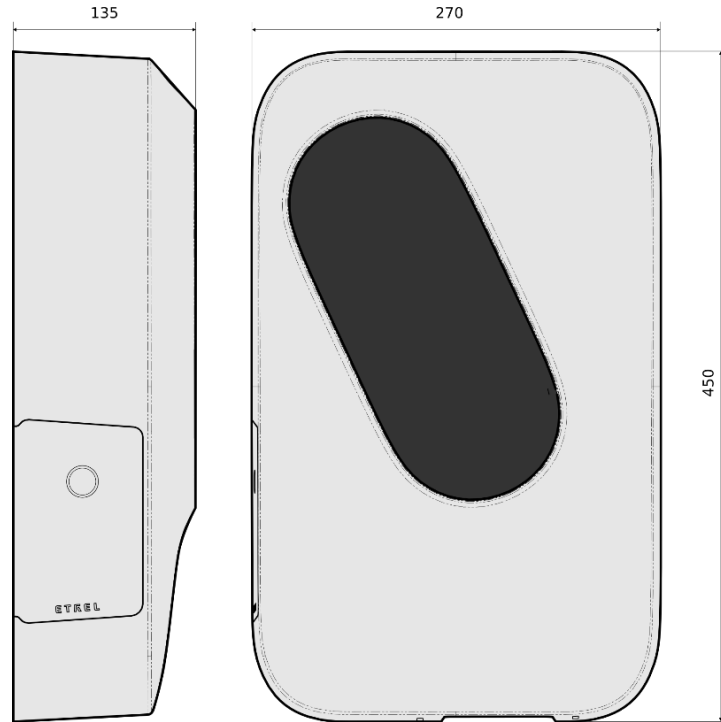

Figure 1: INCH dimensions

Additional considerations of dimensions:

- Basic dimensions of the station: 450 mm x 270 mm x 135 mm
- Basic dimensions of the mounting pole base: 242 mm x 157 mm
- Free space needed:
  - 150 mm on the left and right side.
  - 500 mm at the front (space to enable simple operation and maintenance).

Charging station is equipped with standard socket or vehicle connector (Type 2 according to EN 61851-1 or EN 62196-2). EV parking place must be placed within the reach of the charging cable.

### CONTENT, OPTIONAL AND EXTRA EQUIPMENT

- Charging station (with Type 2 cable or Type 2 socket),
- Wall mounting bracket,
- 9 × wall plugs for securing the mounting bracket to the wall,
- 9 × screws to mount the bracket to the wall,
  - Screws dimensions: 4.5 x 40 and 4.5 x 60 [mm],
- Cable gland rubber seal for smaller cable dimensions
- \*9 × wall spacers
- \*2 × keys to open charging station service doors,
- \*Hex key to open charging station maintenance doors,
  - Hex key dimensions: 2.5
- \*Magnetic cable holder,
- \*Etrel Load Guard device.

*\*Optional, depending on the purchased model.*

## TOOLS

To execute the installation of charging station multiple tools are needed:

- Screwdriver,
- Hex screwdriver (if charging station without key lock on maintenance doors),
- Utility knife,
- Self-adjusting crimping pliers for cables' end sleeves,
- Wire trippers and
- Cable rippers.



Figure 2: Equipment used for the installation of charging station

## 2

**PRODUCT DESCRIPTION**

The Etre's charging station INCH is highly configurable and can be tailored to the client's specific needs. It allows charging of electric vehicle with power of up to 22,08 kW and can be equipped with any standard Type 2 socket or vehicle connector (EN 61851 or EN 62196-2).



*The actual number of maximal charging power can differentiate the exact value for one charging spot considering voltage of 230 V is 22,08 kW.*

*Charging is limited to 32 A, however voltage specified as 230 V, can be between 207 V and 253 V (+- 10 %). This means that the actual charging power can be lower or higher of the specified 22,08 kW.*

*Another factor heavily influencing what is the charging power is the power factor (cos  $\Phi$ ), which is determined by the internal charger in the electric vehicle. This factor is always lower than one, meaning that all power is not active, there is also reactive component. The correct designation of charging power would therefore be 22,08 kVA.*

*No matter the specifics, the charging power of Mode 3 charging spot is commonly referenced as 22 kW. This simplification is used in this document as well.*

Charging station comes with the LCD screen that guides through the charging process and provides important charging information. Charging station comes with several connectivity options (including Wi-Fi, LTE and Ethernet) and open protocol support and can be seamlessly integrated in the smart home system.

Certified utility-grade MID meters or other options (MCB, RCD) can be installed in the station. The station can be equipped with an RFID identification module, which prevents unauthorized use and is necessary to enable different billing and reservation processes and other advanced functionalities. The station also supports remote identification with SMS or other external identification means.

The casing of the charging station is robust enough to withstand any unfavourable weather conditions and potential damage which may occur in open public areas. The compact dimensions of the charging station allow its installation in a small area, for example close to the edge of the pavement or roadside curb.

The design allows easy replacement of key components that can be damaged due to wear or vandalism (especially charging sockets).



## COMPONENTS OVERVIEW

The Etrel INCH charging station contains the following components:

- Casing of the station,
- charging spot (Type 2 socket or vehicle connector, single- or three-phase),
- main controller of the station,
- LCD display that guides user through the charging process,
- optional user identification module with RFID card reader,
- ethernet communication connection point,
- possible built-in smart energy meter,
- three-phase grid connection point optionally equipped with standard electrical safety protection required by local regulation.



1. LCD screen
2. Status light
3. Settings button
4. Confirmation button
5. Socket
6. Maintenance doors
7. Charging cable



Figure 3: Etrel INCH with socket

Figure 4: Etrel INCH with cable

## BASE SPECIFICATIONS



- **Input:** 2x230/400V~; 3W+N+PE; 50/60 Hz; 32 A<sub>max</sub>
- **Output:** 2x230/400V~; 3W+N+PE; 50/60 Hz; 32 A<sub>max</sub>
- **Maximum charging power:** 7.4 kW (1-phase), 22 kW (3-phase)
- **Device power consumption:**  
From 5 W, depending on the actual configuration.

## **GRID CONNECTION**

The charging station can be connected directly to the electricity distribution network or to an existing electrical installation nearby. Supply power depends on the charging power of each socket (according to the configuration of the charging station).

The following supply power is required:

- **22 kW (32 A):** three-phase charging spots with cable or with socket. The maximum charging current is 32 A per phase.

Supply power of the charging station must be dimensioned appropriately.

Charging power can be limited in the settings of the charging station on the scale between 6 A and 32 A. The charging station can also be set up to allow local power management for a cluster of charging stations.

In the execution phase of the grid connection project, the following requirements need to be met:

- Selectivity of the functioning of protection devices needs to be ensured:
  - The main overcurrent protection should be at least one class greater than the one used for the protection of the charging station or have a higher delay.
  - Differential protection (RCD) which is used in the charging station operates at a low current ( $\Delta I$  30 mA, without delay). The selectivity of this protection on the level of facility is achieved with a higher delay or a greater current differential.
- Five wires are routed to the station, including three phase wires, grounding wire, and the neutral wire (when connecting to an existing installation). For single phase connection (slow charging option), only one phase wire with sufficient diameter can be routed to the station, together with neutral and earthing conductor. Dimensioning of the wires is determined in the project documentation. Grounding wire must be connected to the main grounding busbar.

## **CONNECTION TO THE STATION OPERATOR'S COMMUNICATION NETWORK**

The charging station uses network connection to communicate with the Control centre to cyclically send information about its status, perform identification of users (on the Control centre level), forward events that occur during its operation and execute billing for the services performed.

The connection also enables communication from the Control centre towards the charging station, which enables remote access to the station for needs of maintenance or remote control.

The charging station could require a connection to the station operator's WAN network (charging infrastructure control centre). To access the WAN network via an internet connection, some additional security requirements need to be observed.

Network connection can be executed in several different ways:

- Direct connection to the station operator's WAN network. Connection can be established directly with a UTP cable or a fibre optic converter.
- Wireless connection. The station connects to an existing 2G/3G/4G mobile network with an GPRS/UMTS router built into the station.

Specification of frequency bands and transmitting power (it is possible that not all modules are part of an actual device).

<p><b>LTE module</b></p> <p><u>Frequency bands:</u></p> <p>LTE-FDD: B1 (2100 MHz), B3 (1800 MHz), B5 (850 MHz), B7 (2600 MHz), B8 (900 MHz), B20 (800 MHz)</p> <p>LTE-TDD: B38 (2600 MHz), B40 (2300 MHz), B41 (2500 MHz)</p> <p>WCDMA: B1 (2100 MHz), B5 (850 MHz), B8 (900 MHz)</p> <p>GSM/EDGE: B3 (1800 MHz), B8 (900 MHz)</p> <p><u>Transmitting power:</u></p> <p>33dBm±2dB for GSM</p> <p>24dBm+1/-3dB for WCDMA</p> <p>23dBm±2dB for LTE-FDD</p> <p>23dBm±2dB for LTE-TDD</p>	<p><b>LTE Router</b></p> <p><u>Frequency bands:</u></p> <p>4G (LTE-FDD): B1 (2100 MHz), B3 (1800 MHz), B5 (850 MHz), B7 (2600 MHz), B8 (900 MHz), B20 (800 MHz)</p> <p>4G (LTE-TDD): B38 (2600 MHz), B40 (2300 MHz), B41 (2500 MHz)</p> <p>3G: B1 (2100 MHz), B5 (850 MHz), B8 (900 MHz)</p> <p>2G: B3 (1800 MHz), B8 (900 MHz)</p> <p><u>Transmitting power:</u></p> <p>21.9 dB</p>
<p><b>Wi-Fi module</b></p> <p><u>Frequency band:</u></p> <p>2.4 - 2.4835 GHz</p> <p><u>Transmitting power:</u></p> <p>up to 15 dBm</p>	<p><b>RFID module</b></p> <p><u>Frequency band:</u></p> <p>13.56 MHz (HF)</p> <p><u>Transmitting power:</u></p> <p>up to 8 dBm</p>

## CIRCUIT DIAGRAM

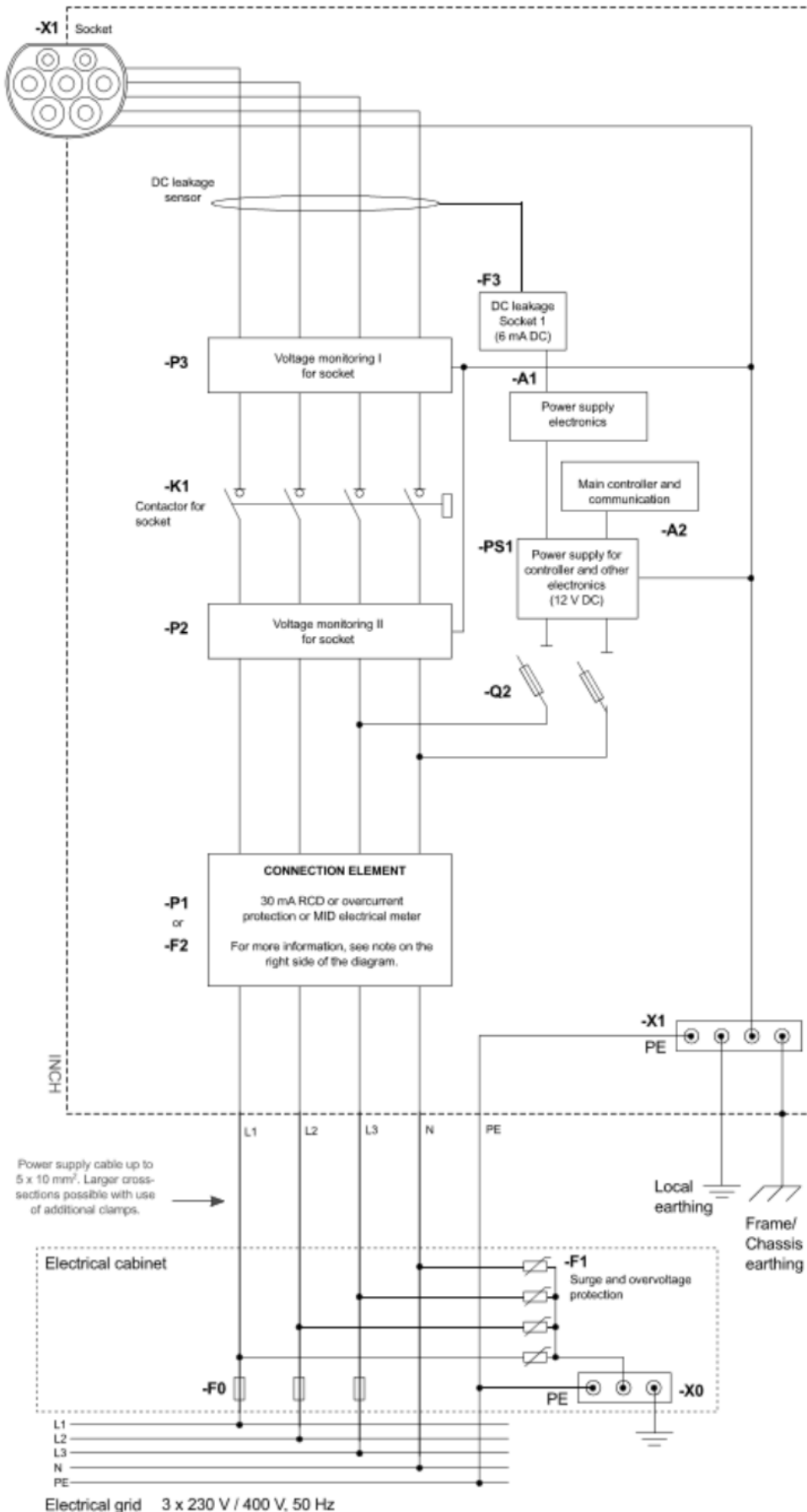

### NOTE:

#### CONNECTION ELEMENT

Connection element is used to connect supply cables to the charging station. It can be either of the three components specified below (A, B or C), depending on the version of the product.

#### (A) Overcurrent protection

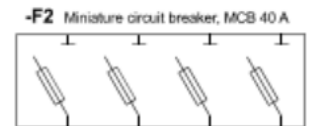

#### (B) Measurement of the consumed energy

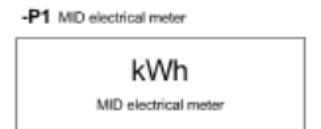

#### (C) Residual current device

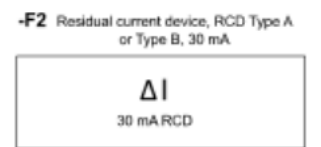

Actual wiring of a product can be different across different versions of the product.

## **EXTERNAL SIGNAL**

If hardware that is installed in the charging station supports connection of external signals to the charger, the additional connector above Ethernet connector in the service area will be present.

## **DIGITAL INPUTS AND DIGITAL OUTPUTS**

Charger supports connecting two digital inputs and one digital output. Inputs and outputs are operating on 12 VDC, therefore two of the pins are also 12 VDC and GND. Check pinout on the image below.

The use and logic of these digital input and outputs is settable via web interface of the charging station.

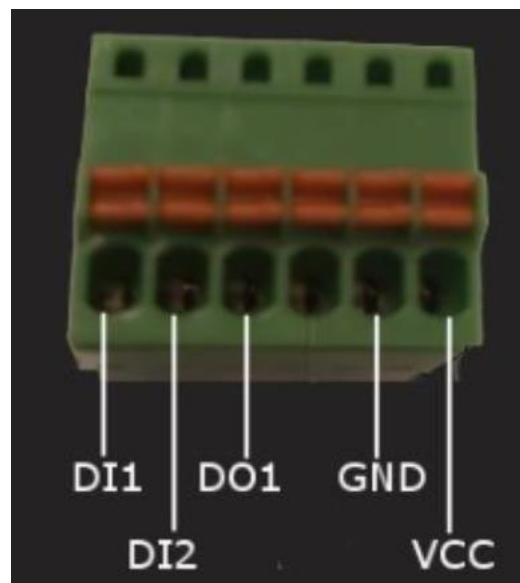

Figure 5: Pins of connector for digital inputs and outputs



**Do not use external 12 VDC for power supply. Digital output allows maximal load of 100 mA! Be careful not to make short circuit, which could be dangerous to persons and could also damage the charging station.**

## 3

**CABLE CROSS-SECTION SELECTION**

The required cable cross-section is determined considering the maximum current, the allowable voltage drop and the expected short-circuit current. Cross-section can be determined by calculation or from a table, in the usual way, in accordance with IEC 60364-5-52.

When determining the cross-section of the cables, it is also necessary to include the method of installation, the material of the conductors and the insulation material. The temperature conditions at the location and the length of the cable also have an impact.

In general, the cable cross-section for the INCH connection is between 4 - 10 mm<sup>2</sup>, dependant on the installation method. Larger distances or clustering of several charging stations could require cables with larger cross-section and to connect INCH additional junction box is needed.

We recommend that at least the specified cable cross-section is selected for all phase conductors, for the neutral conductor and for the protective conductor. When choosing cables with a larger cross-section, the losses will be smaller, which is especially important for longer cable routes.

**MINIMUM CABLES CROSS-SECTION**

The calculation of necessary cables cross-sections should be part of electrical project and should consider the specifics of the actual location. The plan of installation should be prepared by licensed electrician or electrical planner in accordance with national legislation. Values given in this chapter are only informational.

The cables cross-sections are determined by three criteria:







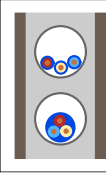

- Continuous operating current.
- Voltage drop.
- Short circuit withstand.

**CONTINUOUS OPERATING CURRENT**

The cross-section of cables must be large enough that continuous charging with maximal current is safe and does not damage the cables. Different installation options and environmental conditions are possible.

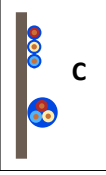
In the following table, the installation method can be checked for the minimum cable cross-section when connecting one INCH charging station. These values apply for copper conductors with XLPE insulation at reference air temperature of 35 ° C. For installation of cables in the ground, temperature of the ground is set as 25 ° C and soil thermal resistivity as 2.5 K\*m/W. Charging current of 32 A is being considered.

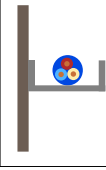
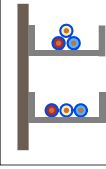
**Table 1: Minimum cable cross-section for continuous operating current of 32 A.**

 <p><b>A1</b></p>	<p><b>A1 - Insulated single core conductors in conduit in a thermally insulated wall</b></p>	<p><b>A1, A2:</b></p>
 <p><b>A2</b></p>	<p><b>A2 - Multicore cable in conduit in a thermally insulated wall</b> This method also applies to single core or multicore cables installed directly in a thermally insulated wall (use methods A1 and A2 respectively), conductors installed in mouldings, architraves and window frames.</p>	<p><b>10 mm<sup>2</sup></b></p>
 <p><b>B1</b></p>	<p><b>B1 - Insulated single core conductors in conduit on a wall</b></p>	<p><b>B1:</b></p>
 <p><b>B2</b></p>	<p><b>B2 - Multicore cable in conduit on a wall</b> This method applies when a conduit is installed inside a wall, against a wall or spaced less than 0.3 x D (overall diameter of the cable) from the wall. Method B also applies for cables installed in trunking / cable duct against a wall or suspended from a wall and cables installed in building cavities.</p>	<p><b>6 mm<sup>2</sup></b></p>
 <p><b>C</b></p>	<p><b>C - Single core or multi-core cable on a wooden wall</b></p>	<p><b>C:</b></p>
<p>This method also applies to cables fixed directly to walls or ceilings, suspended from ceilings, installed on unperforated cable trays (run horizontally or vertically), and installed directly in a masonry wall (with thermal resistivity less than 2 K.m/W).</p>	<p><b>6 mm<sup>2</sup></b></p>	
 <p><b>D1</b></p>	<p><b>D1 - Multicore or single core cables installed in conduit buried in the ground</b></p>	<p><b>D1, D2:</b></p>
 <p><b>D2</b></p>	<p><b>D2 - Multicore or single core cables buried directly in the ground</b></p>	<p><b>6 mm<sup>2</sup></b></p>
 <p><b>E</b></p>	<p><b>E - Multicore cable in free-air</b></p>	<p><b>E:</b></p>
<p>This method applies to cables installed on cable ladder, perforated cable tray or cleats provided that the cable is spaced more than 0.3 x D (overall diameter of the cable) from the wall. Note that cables installed on unperforated cable trays are classified under Method C.</p>	<p><b>4 mm<sup>2</sup></b></p>	
 <p><b>F</b></p>	<p><b>F - Single core cables touching in free-air</b></p>	<p><b>F:</b></p>
<p>This method applies to cables installed on cable ladder, perforated cable tray or cleats provided that the cable is spaced more than 0.3 x D (overall diameter of the cable) from the wall. Note that cables installed on unperforated cable trays are classified under Method C.</p>	<p><b>25 mm<sup>2</sup></b></p>	
 <p><b>G</b></p>	<p><b>G - Single-core cables laid flat and spaced in free-air</b></p>	<p><b>G:</b></p>
<p>This method applies to cables installed on cable ladder, perforated cable tray or cleats provided that the cable is spaced more than 0.3 x D (overall diameter of the cable) from the wall and with at least 1 x D spacings between cables. Note that cables installed on unperforated cable trays are classified under Method C. This method also applies to cables installed in air supported by insulators.</p>	<p><b>25 mm<sup>2</sup></b></p>	

The installation option F and G are not advised, as additional junction box is needed to enable connecting cables with cross-section larger than 10 mm<sup>2</sup>.

At sites, where the cross-section of already existent cables is smaller than recommended minimum, the limitation of maximal current can be made in the charging station's web interface to allow the connection of charging station, without the need to replace all the cables.

**VOLTAGE DROP**

The requirement for the maximum voltage drop of the installation can be different across different countries. Usually, it is required that the voltage drop of the installation is below 4 % (or in some cases below 5 %).

The length of the conductors and charging current are major factors determining the adequacy of cables cross-section, however voltage drop occurs on other components or devices as well. Because of it, some reserve should be considered when selecting cables cross-section.

**Table 2: Voltage drop in conductors with 6 mm<sup>2</sup> cable cross-section and charging current of 32 A.**

Charging current 32 A	Conductor 6 mm <sup>2</sup> Single phase	Conductor 6 mm <sup>2</sup> Three phase
L - length [m]	Voltage drop [%]	Voltage drop [%]
10	0,90	0,78
20	1,80	1,56
30	2,70	2,33
40	3,59	3,11
50	4,49	3,89

**Table 3: Voltage drop in conductors with 10 mm<sup>2</sup> cable cross-section and charging current of 32 A.**

Charging current 32 A	Conductor 10 mm <sup>2</sup> Single phase	Conductor 10 mm <sup>2</sup> Three phase
L - length [m]	Voltage drop [%]	Voltage drop [%]
10	0,54	0,47
20	1,09	0,94
30	1,63	1,41
40	2,18	1,88
50	2,72	2,36
60	3,26	2,83
70	3,81	3,30
80	4,35	3,77

Lower voltage drop also means that the power losses of charging process will be lower. The life cycle assessment and calculation of benefit of using cables with larger cross-section could help mitigate the higher cost of investment.

**SHORT CIRCUIT WITHSTAND**

Charging station INCH can have already installed miniature circuit breaker which protects against overload and short circuit. This protection can also be part of installation with different tripping characteristics.



Short circuit protection lowers the possible short-circuit and its duration that downstream installed devices can be subjected to. Normally, 2 kA short circuit of 10 ms duration could be considered for calculations of cables cross-section to withstand short circuit.

Cable with cross-section of 4 mm<sup>2</sup> is enough to withstand current pulse of 3 kA in duration of 20 ms and cable with cross-section of 6 mm<sup>2</sup> is enough to withstand 5 kA, 20 ms. These values suggest that short-circuit withstand will not be the strictest criterion.

## **OTHER CONSUMPTION OR PRODUCTION OF ELECTRICITY AT THE LOCATION**

In cases, where there are other loads at the location and there is a possibility that the total load (other loads + charging) overcomes the limitation of the grid connection point, the charging should be controlled.

Because the charging station needs information of other loads (or production) to be able to react appropriately, Etrel Load Guard device can be used.

### **LOAD GUARD**

By using Load Guard device, other loads or production can be measured and used in overload prevention algorithms:

- Static limit of maximum allowed charging current per phase.
- Static limit of maximum allowed charging current per phase in case connection with Load Guard sensor or with Back-End System is lost.
- Detection and visualisation of available supply and automatic adjustment of charging power.
- Detection and visualisation of surplus energy returned to the grid (Production from renewable energy sources).

When the user connects EV to charger, and prior to beginning of charging, the charger determines the current available for charging as the difference between the rated current of the main fuse (reduced by a safety margin that can be pre-set by the user via charger's web interface) and the last measurement received from Load guard.

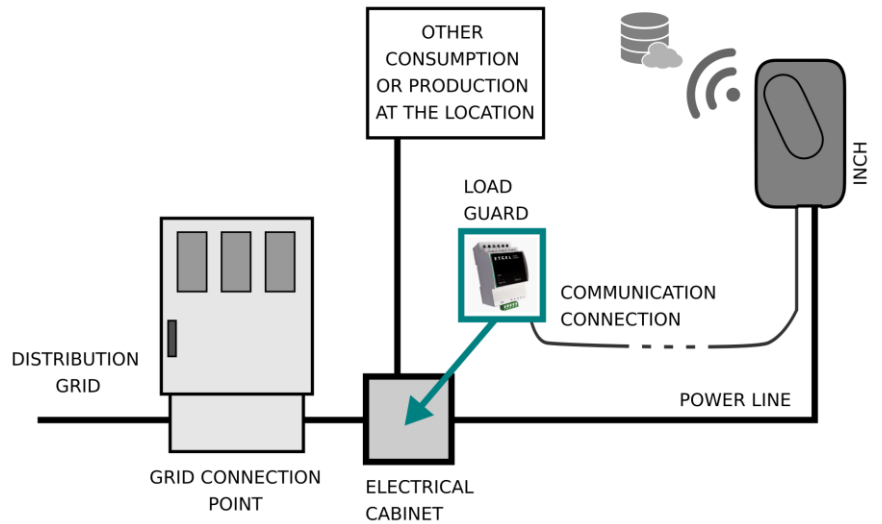

Figure 6: Use of additional consumption data to prevent overload

When there is local production of energy present at the location (e.g., photovoltaics), the available charging current can be higher, and the use of Load Guard make possible to always charge with maximum available current.

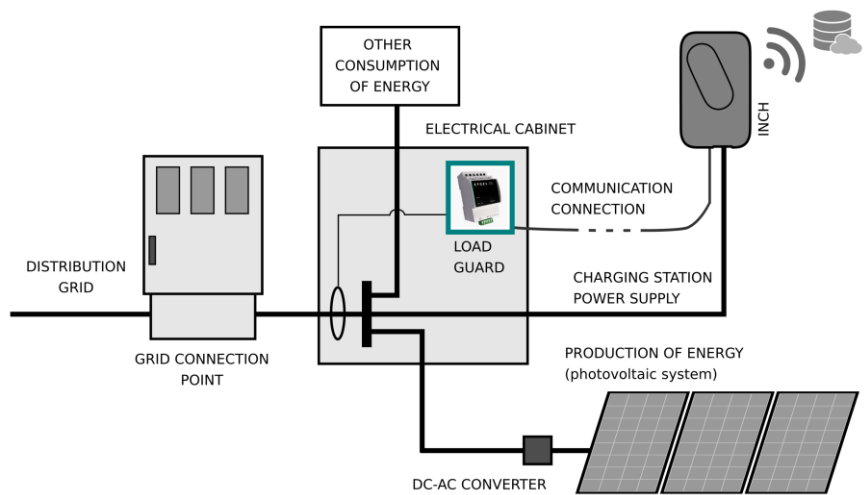

Figure 7: Use of additional consumption and production data to prevent overload

## 4

## DIMENSIONING OF A CLUSTER

**INCH Home is not intended for large clusters, as only two charging stations can be connected to be a part of cluster. Large clusters are only possible using INCH Pro charging station.**

When selecting the cluster configuration and cluster master it is important to know that INCH Pro can handle power management of up to 36 electric vehicles. This is valid for the most unfavourable scenario with low power capacity available, meaning constant need for power management recalculations with inclusion of data obtained from Load Guard. INCH Pro could also control larger clusters, depending on the individual case. Larger cluster (supply of up to 300 electric vehicles in most unfavourable scenario) is possible with use of industrial computer and connection to EtreI Ocean management software. In this case all connected charging stations of the cluster must be INCH Pro. INCH Home can control only two units.

Main decision factor in cluster configuration is usually the available charging power at the location. Cluster of charging stations can be planned and configured to allow charging with maximal power to all connected vehicles. Another option is to plan to the limitation of capacity intended for charging and to maximal charging current of the cluster.

When a larger number of parking spots need to be covered with charging stations, the general proposal is to have a dedicated parking spot for each charging connector that can offer at least charging with minimum current of 6 A to connected electric vehicle.

Example:

- 1) Ten INCH Pro charging stations can be configured to be able to charge with maximal charging current of 32 A per each of three phases, per each charging spot. Ten INCH Pro charging stations have 10 charging spots, with maximal charging current of 320 A per phase, meaning that maximal charging power is 220,8 kW.
- 2) Ten INCH Pro charging stations can also be configured to be able to charge only with minimal charging current of 6 A per each of three phases. These ten INCH Pro charging stations will have maximal charging current of 60 A per phase, meaning that maximal charging power is 41,4 kW.
- 3) Ten INCH Pro charging can also be configured to be able to charge only with minimal charging current of 6 A per one phase (physical connection in single-phase). Ten INCH Pro charging stations have 10 charging spots, with maximal charging current of 320 A divided among three phases (e.g., 4 units connected to phase 1, 3 units connected to phase 2 and 3 units connected to phase 3), meaning the maximal charging power is 13,8 kW.

Normally the cluster is dimensioned for available power and power management limits the total current of the cluster to allowable levels. Also, possible future upgrades should be considered and could lead to decision to install cables with larger cross-sections.

In case of very large clusters, possible dedicated power transformers could be needed to provide low enough voltage drop.

## **CABLING ROUTE FOR THE CONNECTION OF MULTIPLE CHARGING STATIONS**

Charging station can be installed independently or combined in connection with other stations (the so-called clustering of charging stations).

When multiple charging stations are installed in a single area, the power supply cables can be routed in several different ways. The physical connection of a group of charging stations can be different than the setting of software grouping.

It is recommended, that the charging stations logically belonging to one cluster are also physically connected to the same cluster with common point of power supply.

The main reason would be possible power management of the cluster and limitation of charging power on basis of set and measured data. Also, avoidance of possible confusion during the maintenance or troubleshooting.

Cluster can be defined only on level of charging stations where one charging station is designated as cluster master. They can also be managed from charging infrastructure management system.

### **POWER CABLES STAR NETWORK TOPOLOGY**

Power cables of the charging stations are connected to the common point (electrical cabinet in the following figure).

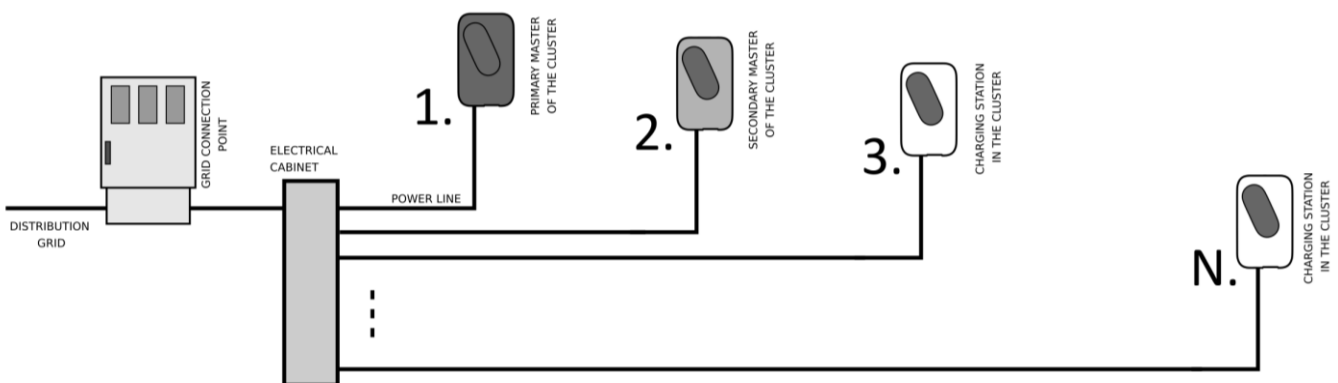

Figure 8: Cluster cabling route for multiple charging stations - star network topology

**POWER CABLES POINT TO POINT NETWORK TOPOLOGY**

Power cables are routed to the first station, which is then connected to the next station with a separate power cable and a separate communication cable. Each additional station is then connected in the same way with its preceding station.

In case that Point-to-Point communication is needed for the power supply, additional junction boxes with double terminal clamps for division of power cables should be installed.

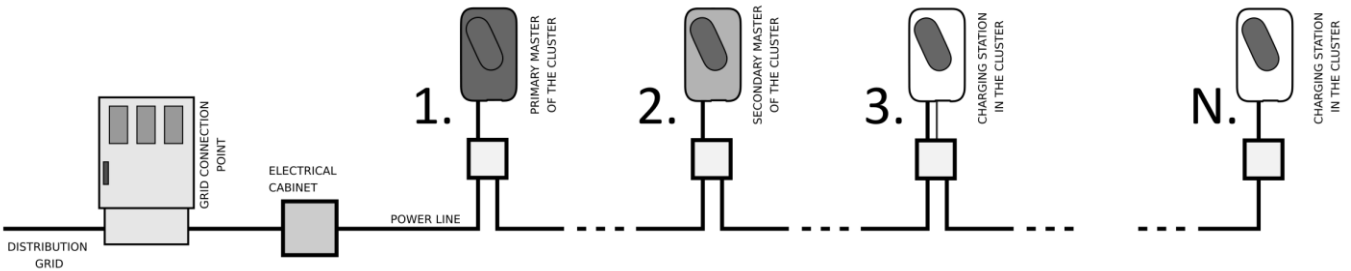

Figure 9: Cluster cabling route - point to point network topology (daisy chain)

**POWER CABLES HYBRID NETWORK TOPOLOGY**

When considering large clusters, the power supply network topology will most often be a hybrid of star and point to point network topology. The requirements that each charging spot needs to be protected by residual current protection device (RCD) and by short-circuit and overcurrent protection device (fuses or MCB) and by surge and over-voltage protection (SPD) and in particular because of additional double terminal clamps needed to enable point-to-point topology leads to the fact that additional electrical boxes will be needed in most cases.

**COMMUNICATION**

Although charging without network connection is possible, to enable common charging scenarios, network connection is required. Larger clusters are usually also connected to control centre, enabling remote control and management.

Cluster of charging stations can be connected to the network with UTP cable or with ADSL cable to the existing ethernet network, or ethernet network can be created only for the charging stations. The connection can also be over Wi-Fi.

One of the charging stations is designated as a cluster master and represents one point of management for the complete cluster.

All the charging stations of the cluster need to be connected to the network. The communication cables should follow star network topology. Point-to-Point wiring of communication cables is not fully supported yet.

**Table 4: Power cables installation method**

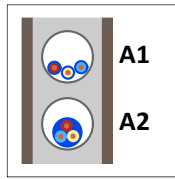

**A1 - Insulated single core conductors in conduit in a thermally insulated wall**

**A2 - Multicore cable in conduit in a thermally insulated wall**

This method also applies to single core or multicore cables installed directly in a thermally insulated wall (use methods A1 and A2 respectively), conductors installed in mouldings, architraves and window frames.

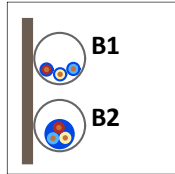

**B1 - Insulated single core conductors in conduit on a wall**

**B2 - Multicore cable in conduit on a wall**

This method applies when a conduit is installed inside a wall, against a wall or spaced less than  $0.3 \times D$  (overall diameter of the cable) from the wall. Method B also applies for cables installed in trunking / cable duct against a wall or suspended from a wall and cables installed in building cavities.

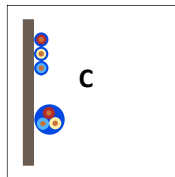

**C - Single core or multi-core cable on a wooden wall**

This method also applies to cables fixed directly to walls or ceilings, suspended from ceilings, installed on unperforated cable trays (run horizontally or vertically), and installed directly in a masonry wall (with thermal resistivity less than  $2 \text{ K.m/W}$ ).



**D1 - Multicore or single core cables installed in conduit buried in the ground**

**D2 - Multicore or single core cables buried directly in the ground**

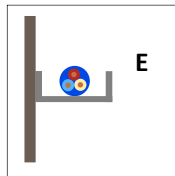

**E - Multicore cable in free-air**

This method applies to cables installed on cable ladder, perforated cable tray or cleats provided that the cable is spaced more than  $0.3 \times D$  (overall diameter of the cable) from the wall. Note that cables installed on unperforated cable trays are classified under Method C.

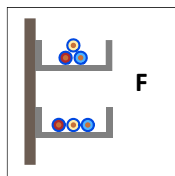

**F - Single core cables touching in free-air**

This method applies to cables installed on cable ladder, perforated cable tray or cleats provided that the cable is spaced more than  $0.3 \times D$  (overall diameter of the cable) from the wall. Note that cables installed on unperforated cable trays are classified under Method C.

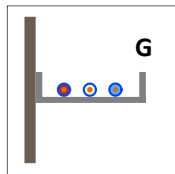

**G - Single-core cables laid flat and spaced in free-air**

This method applies to cables installed on cable ladder, perforated cable tray or cleats provided that the cable is spaced more than  $0.3 \times D$  (overall diameter of the cable) from the wall and with at least  $1 \times D$  spacings between cables. Note that cables installed on unperforated cable trays are classified under Method C. This method also applies to cables installed in air supported by insulators.

## **CLUSTER CABLES CROSS-SECTION**

When INCH Pro is designated as cluster master, it is possible to connect 36 INCH Pro charging stations to this cluster, meaning that charging is supported to 36 electric vehicles simultaneously. If industrial computer is designated as cluster master, it is possible to connect 300 INCH Pro charging stations in the same cluster, meaning that charging is supported to 300 electric vehicles simultaneously.

Considering maximal charging current of Mode 3 AC conductive charging point of 32 A (three-phase), the maximal charging power is 22,08 kW. In large clusters this number rise significantly and can be in a range of large industrial consumers.

The currents presented in the following table require additional considerations from the electrical works planning view, which should be determined in the electrical project. It is possible, that high charging current would require implementation of bus-bar systems and/or possible installation of power transformers and/or additional requirements from the view of electrical safety and documentation preparation.

**Table 5: Considering maximal current in case of clusters**

Number of INCH Pro	Number of electric vehicles	Max. charging current (per phase)	Maximal charging power
10	10	320 A	220,8 kW
20	20	640 A	441,6 kW
30	30	960 A	662,4 kW
40	40	1280 A	883,2 kW
50	50	1600 A	1104 kW
60	60	1920 A	1324,8 kW

Main factor influencing the design of a cluster is the available charging power at the location of cluster installation. This limitation can also be expressed as maximal current.

When considering charging with full power the available capacity can quickly run out even with small numbers of simultaneously charged vehicles. INCH Pro has implemented power management functionalities with option of software limitation of maximal current of charging for individual charging station or for complete cluster.

Almost all vehicles require minimally 6 A of charging current. Considering that there are some vehicles that require higher minimal charging current, some reserve to the numbers in the following table should be added to ensure all connected vehicles can charge simultaneously.

**Table 6: Considering minimal current in case of clusters (three-phase wiring)**

Number of INCH Pro	Number of electric vehicles	Min. charging current (per phase)	Maximal charging power
10	10	60 A	41,4 kW
20	20	120 A	82,8 kW
30	30	180 A	124,2 kW
40	40	240 A	165,6 kW
50	50	300 A	207 kW
60	60	360 A	248,4 kW

In the previous table the numbers represent the case when the wiring is still three-phase. Such system allows charging of individual electric vehicles with maximal power of 22,08 kW.

Power management can be used to set limitation of the maximal current of the complete cluster (determined by the location, e.g., main fuses). If this limitation is active, individual charging stations limit the charging power of the connected vehicles.

When the location capacity is very low, there is option to connect charging stations in single-phase connection, cycling the phases of the connection of individual INCH Pro.

**Table 7: Considering minimal current in case of clusters (single-phase wiring)**

Number of INCH Pro	Number of electric vehicles	Min. charging current (divided to three phases)	Maximal charging power
10	10	60 A	13,8 kW
20	20	120 A	27,6 kW
30	30	180 A	41,4 kW
40	40	240 A	55,2 kW
50	50	300 A	69 kW
60	60	360 A	82,8 kW

Such system allows charging of individual electric vehicles with maximal power 7,36 kW.

**Considering that there are some vehicles that require higher minimal charging current, some reserve to the numbers in the following table should be added to ensure all connected vehicles can charge simultaneously.**

**All presented values are only indicative and are not a substitution for exact calculation of required cross-sections. Specified voltage drops are considering only voltage drop in a cable of defined cross-section and for specified current.**

**When calculating complete voltage drop of installation, the lowering of voltage across all the elements of the current path should be taken into consideration.**

**CONTINUOUS OPERATING CURRENT**

Determining the right cross-section of conductors, the method of installation need to be considered. Additional consideration is the material of the conductor and material of its isolation. The real current must also be determined using the selected planning temperature. Informational values of minimal cables cross-section were selected using the following:

- Three-phase system with copper conductors with XLPE insulation



- Ambient temperature 35 °C
- Ground temperature 25 °C
- Thermal resistivity of the soil 2,5 K·m/W

Table 8: Minimal cables cross-sections under specified conditions (1/2)

Current of the cluster [A]		32	64	96	128	160	192	224
Method of installation A1 [mm]		6	16	35	50	70	95	120
Method of installation A2 [mm]		6	16	35	70	95	120	150
Method of installation B1 [mm]		4	16	25	35	50	70	95
Method of installation B2 [mm]		4	16	25	50	70	95	120
Method of installation C [mm]		4	10	25	35	50	70	95
Method of installation D1 [mm]		4	16	35	50	70	120	150
Method of installation D2 [mm]		4	16	25	50	70	95	120
Method of installation E [mm]		2,5	10	16	25	35	50	70
Method of installation F [mm]		25	25	25	25	35	50	50
Method of installation G [mm]		25	25	25	25	25	35	50

Table 9: Minimal cables cross-sections under specified conditions (2/2)

Current of the cluster [A]		256	288	320	352	384	416	448
Method of installation A1 [mm]		150	185	240	240	300	300	X
Method of installation A2 [mm]		185	240	240	300	X	X	X
Method of installation B1 [mm]		95	120	150	185	240	240	300
Method of installation B2 [mm]		120	185	185	240	300	300	X
Method of installation C [mm]		95	120	150	150	185	240	240
Method of installation D1 [mm]		185	240	300	X	X	X	X
Method of installation D2 [mm]		150	185	240	240	300	X	X
Method of installation E [mm]		70	95	95	120	120	150	150
Method of installation F [mm]		70	70	95	95	120	150	150
Method of installation G [mm]		50	70	70	95	95	120	120

### VOLTAGE DROP

The requirement for the maximum voltage drop of the installation can be different across different countries. Usually, it is required that the voltage drop of the installation is below 4 % (or in some cases below 5 %).

The length of the conductors and charging current are major factors determining the adequacy of cables cross-section, however voltage drop occurs on other components or devices as well. Because of it, some reserve should be considered when selecting cables cross-section.

In large clusters of charging stations also the distances can be large. Because of it the voltage drop in the cables can be determining factor choosing the cables cross-section and configuration of the cluster.

Voltage drop in the power cable is proportional to the current of the load. When installing two INCH Pro charging stations, also voltage drops are twice as high as in case of one INCH Pro without considering any additional elements.

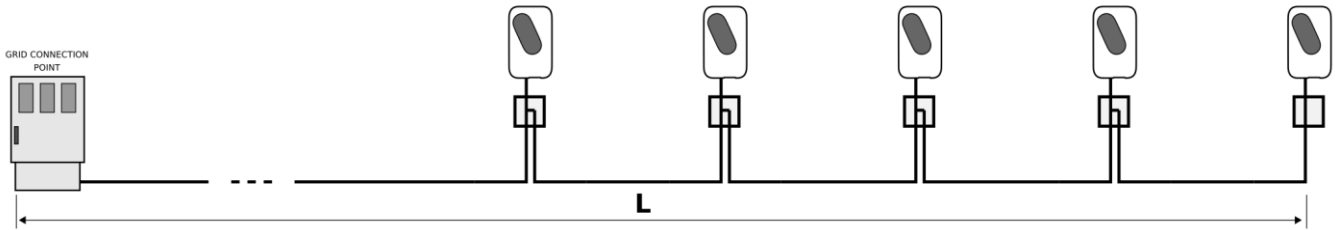

Figure 10: Cluster cabling route length

The voltage drop presented in the tables are calculated for single-phase and three-phase connection. The connection of INCH Pro can be single-phase or three-phase. Using values of voltage drop in single-phase for cases of three-phase connection can represent beneficial reserve when planning the correct cable cross-section.

Table 10: Voltage drop in conductors with 35 mm<sup>2</sup> cable cross-section and charging current of 128 A.

Charging current 128 A (Four INCH Pro with max. current)	Conductor 35 mm <sup>2</sup> Single phase	Conductor 35 mm <sup>2</sup> Three phase
L - length [m]	Voltage drop [%]	Voltage drop [%]
40	2,62	2,27
50	3,28	2,84
60	3,93	3,40

Table 11: Voltage drop in conductors with 50 mm<sup>2</sup> cable cross-section and charging current of 128 A.

Charging current 128 A (Four INCH Pro with max. current)	Conductor 50 mm <sup>2</sup> Single phase	Conductor 50 mm <sup>2</sup> Three phase
L - length [m]	Voltage drop [%]	Voltage drop [%]
60	2,84	2,46
70	3,31	2,87
80	3,78	3,27
90	4,25	3,68

For example, looking at the table determining minimal cross-section of cables for maximal continuous current of 320 A, depending on the installation method, either 70 mm<sup>2</sup> (Method G) or 150 mm<sup>2</sup> (Method C) cables could be used when connecting 10 INCH Pro charging stations with maximum charging current available.

Reviewing the selection of the cable with consideration of voltage drop, shows that allowable distance of conductors is a lot lower than if selecting higher cable cross-section.

Table 12: Voltage drop in conductors with 70 mm<sup>2</sup> cable cross-section and charging current of 320 A.

Charging current 320 A (Ten INCH Pro with max. current)	Conductor 70 mm <sup>2</sup> Single phase	Conductor 70 mm <sup>2</sup> Three phase
L - length [m]	Voltage drop [%]	Voltage drop [%]
40	3,51	3,04
50	4,39	3,80

Table 13: Voltage drop in conductors with 95 mm<sup>2</sup> cable cross-section and charging current of 320 A.

Charging current 320 A (Ten INCH Pro with max. current)	Conductor 95 mm <sup>2</sup> Single phase	Conductor 95 mm <sup>2</sup> Three phase
L - length [m]	Voltage drop [%]	Voltage drop [%]
30	2,03	1,76
40	2,71	2,35
50	3,39	2,93
60	4,06	3,52

Table 14: Voltage drop in conductors with 120 mm<sup>2</sup> cable cross-section and charging current of 320 A.

Charging current 320 A (Ten INCH Pro with max. current)	Conductor 120 mm <sup>2</sup> Single phase	Conductor 120 mm <sup>2</sup> Three phase
L - length [m]	Voltage drop [%]	Voltage drop [%]
50	2,80	2,43
60	3,36	2,91
70	3,93	3,40
80	4,49	3,88

Table 15: Voltage drop in conductors with 150 mm<sup>2</sup> cable cross-section and charging current of 320 A.

Charging current 320 A (Ten INCH Pro with max. current)	Conductor 150 mm <sup>2</sup> Single phase	Conductor 150 mm <sup>2</sup> Three phase
L - length [m]	Voltage drop [%]	Voltage drop [%]
40	1,89	1,64
50	2,36	2,04
60	2,83	2,45
70	3,30	2,86
80	3,78	3,27
90	4,25	3,68

Table 16: Voltage drop in conductors with 240 mm<sup>2</sup> cable cross-section and charging current of 320 A.

Charging current 320 A (Ten INCH Pro with max. current)	Conductor 240 mm <sup>2</sup> Single phase	Conductor 150 mm <sup>2</sup> Three phase
L - length [m]	Voltage drop [%]	Voltage drop [%]
80	2,71	2,35
90	3,05	2,64
100	3,39	2,94
110	3,73	3,23
120	4,07	3,52

Table 17: Voltage drop in conductors with 300 mm<sup>2</sup> cable cross-section and charging current of 320 A.

Charging current 320 A (Ten INCH Pro with max. current)	Conductor 300 mm <sup>2</sup> Single phase	Conductor 300 mm <sup>2</sup> Three phase
L - length [m]	Voltage drop [%]	Voltage drop [%]
100	2,95	2,55
110	3,24	2,81
120	3,54	3,06
130	3,83	3,32
140	4,13	3,57

There are several options considering larger distances of cable path and larger charging currents. The main conductor could have larger cross-section, that could be distributed through junction boxes, each connecting small cluster. The use of busbar trunking systems could be beneficial.

#### SHORT CIRCUIT WITHSTAND

Although the short circuit withstand criterion must be evaluated when dimensioning cables cross-section, in practice the cables cross-section is almost always determined by first two criteria (continuous operating current and voltage drop).

Table 18: Minimum cable cross-section able to withstand specified short circuit

Short circuit	Initial temperature 65 ° C		Initial temperature 35 ° C	
	XLPE, copper	PVC, copper	XLPE, copper	PVC, copper
2 kA, 10 ms	1,28 mm <sup>2</sup>	1,69 mm <sup>2</sup>	1,16 mm <sup>2</sup>	1,43 mm <sup>2</sup>
2 kA, 20 ms	1,81 mm <sup>2</sup>	2,39 mm <sup>2</sup>	1,63 mm <sup>2</sup>	2,03 mm <sup>2</sup>
3 kA, 10 ms	1,91 mm <sup>2</sup>	2,53 mm <sup>2</sup>	1,73 mm <sup>2</sup>	2,15 mm <sup>2</sup>
3 kA, 20 ms	2,71 mm <sup>2</sup>	3,58 mm <sup>2</sup>	2,45 mm <sup>2</sup>	3,04 mm <sup>2</sup>
5 kA, 10 ms	3,19 mm <sup>2</sup>	4,22 mm <sup>2</sup>	2,89 mm <sup>2</sup>	3,58 mm <sup>2</sup>
5 kA, 20 ms	4,51 mm <sup>2</sup>	5,96 mm <sup>2</sup>	4,09 mm <sup>2</sup>	5,07 mm <sup>2</sup>

## EXAMPLES OF CONNECTION

### CASE 1: POWER CABLES FOR CLUSTER OF 30 INCH PRO IN EXPANDED STAR NETWORK

The case presented in the following figure is possible with use of additional junction boxes. The cable cross-sections must be determined in accordance with all three criteria.

The distances are depending on the arrangement of parking spots and available space. One, two or more levels of electrical junction boxes could be used. On the figure three levels are presented and the first could be omitted (the grey box on the left).

Keep in mind that if the cables cross-section changes (e.g., in first junction box, from cross-section used on L1 to cross-section used on L2) and is lowered to level that cannot sustain the full current, the over-current protection element should be installed.

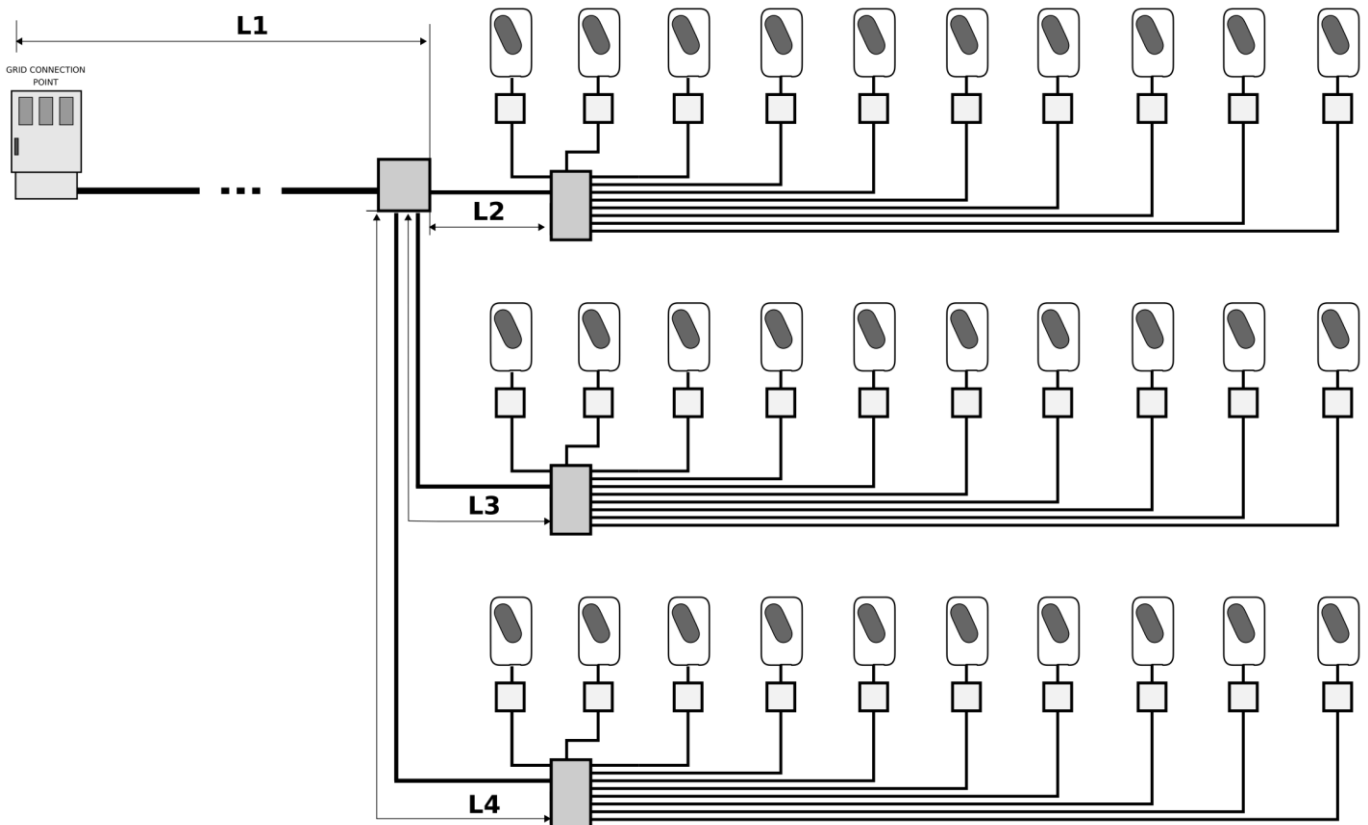

Figure 11: Example of INCH Pro connection

#### Maximal continuous current of the cluster

Maximal operating current of the presented case is 960 A. Cables supporting this current would need to be installed in E, F or G method of installation or a bus-bar system could be used. For cables used at L1, the cross-sections would need to be:

- Method of installation E: 400 mm<sup>2</sup>
- Method of installation F: 500 mm<sup>2</sup>
- Method of installation G: 400 mm<sup>2</sup>

Such a high requirement indicates the possibility of using three main power lines to separate groups of the cluster, each designed for 320 A.

These cables selection is the same as on the presented figure at L2 and L3 and L4, where the maximal operating current is 320 A. Cables used at L2, L3 or L4 would need to have cross-sections of at least:

- Method of installation A1: 240 mm<sup>2</sup>
- Method of installation A2: 240 mm<sup>2</sup>
- Method of installation B1: 150 mm<sup>2</sup>
- Method of installation B2: 185 mm<sup>2</sup>
- Method of installation C: 150 mm<sup>2</sup>
- Method of installation D1: 300 mm<sup>2</sup>
- Method of installation D2: 240 mm<sup>2</sup>
- Method of installation E: 95 mm<sup>2</sup>
- Method of installation F: 95 mm<sup>2</sup>
- Method of installation G: 70 mm<sup>2</sup>

Cables from the 2nd level junction boxes to individual junction box of the charging stations need to be dimensioned for 32 A, with recommended cross-section of 6 mm<sup>2</sup>.

**Voltage drop**

- Voltage drop in cable at L1

**Table 19: Voltage drop in conductors with 400 mm<sup>2</sup> cable cross-section and charging current of 960 A.**

Charging current 960 A	Conductor 400 mm <sup>2</sup> Single phase	Conductor 400 mm <sup>2</sup> Three phase
Distance [m]	Voltage drop [%]	Voltage drop [%]
10	0,75	0,65
20	1,50	1,30
30	2,25	1,95
40	3,00	2,60
50	3,75	3,25
60	4,51	3,90

For 960 A and copper conductors with cross-section of 400 mm<sup>2</sup>, the voltage drop is quite large, indicating the possible need of more main power cable routes or need for limitation of maximal charging current.

- Voltage drop in cable at L2 (L3, L4)

Please check values of voltage drop according to distance and cable cross-section in tables 10-17.

- Voltage drop in cable of charging station connection

Please check values of voltage drop according to distance and cable cross-section in table 2 (and 3).

**CASE 2: POWER CABLES FOR CLUSTER OF 30 INCH PRO IN EXPANDED POINT TO POINT NETWORK**

The case presented in the following figure is possible only with double clamp terminals installed in all individual junction boxes of charging stations, instead of the last one of the power lines (three junction boxes, completely right on the figure). The cable cross-sections must be determined in accordance with all three criteria.

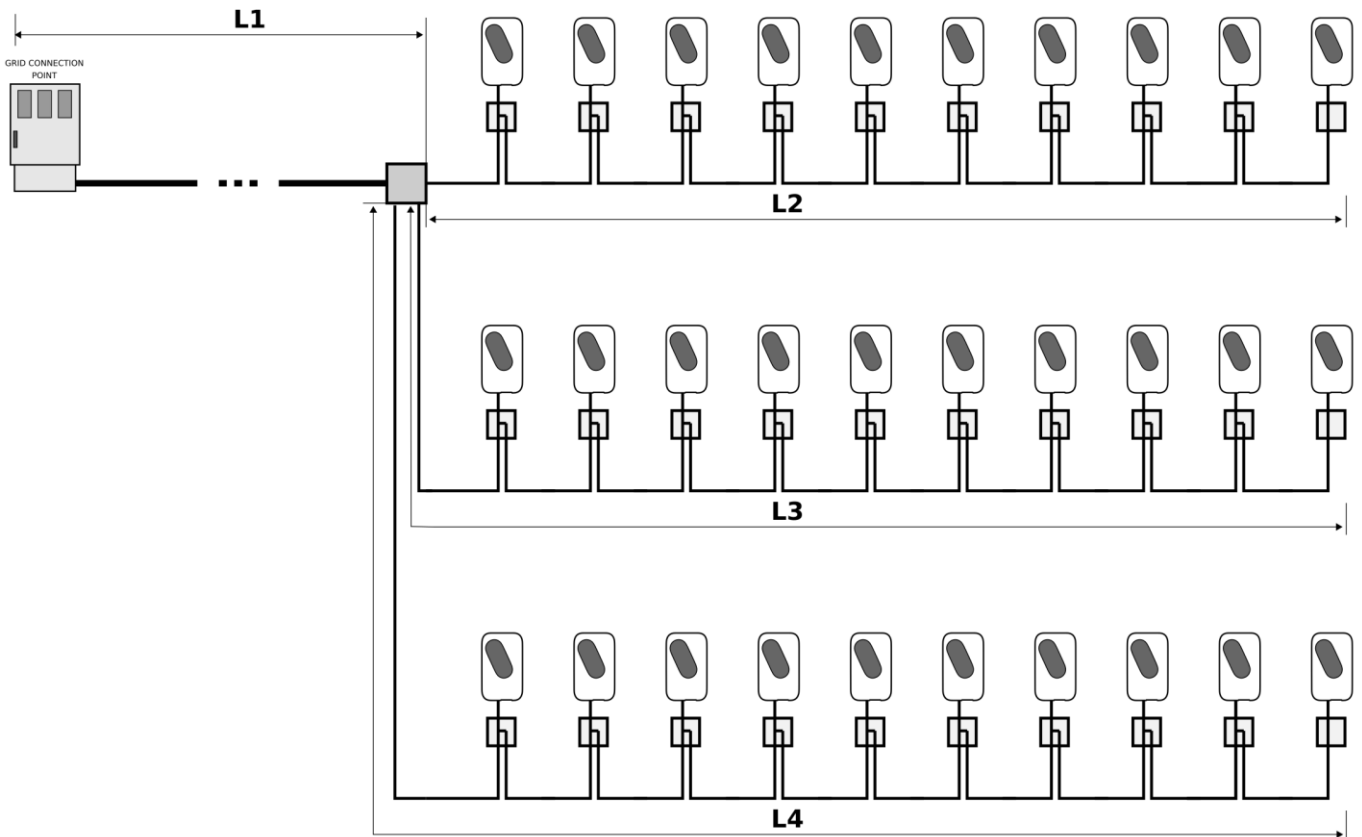

Figure 12: Example of INCH Pro connection – use of double terminal clamps

**Maximal continuous current of the cluster**

Maximal operating current of the presented case is 960 A. Cables supporting this current would need to be installed in E, F or G method of installation or a busbar trunking system could be used. For cables used at L1, the cross-sections would need to be:

- Method of installation E: 400 mm<sup>2</sup>
- Method of installation F: 500 mm<sup>2</sup>
- Method of installation G: 400 mm<sup>2</sup>

Such a high requirement indicates the possibility of using three main power lines to separate groups of the cluster, each designed for 320 A.

These cables selection is the same as on the presented figure at L2 and L3 and L4, where the maximal operating current is 320 A. Cables used at L2, L3 or L4 would need to have cross-sections of at least:

- Method of installation A1: 240 mm<sup>2</sup>
- Method of installation A2: 240 mm<sup>2</sup>
- Method of installation B1: 150 mm<sup>2</sup>
- Method of installation B2: 185 mm<sup>2</sup>
- Method of installation C: 150 mm<sup>2</sup>
- Method of installation D1: 300 mm<sup>2</sup>
- Method of installation D2: 240 mm<sup>2</sup>
- Method of installation E: 95 mm<sup>2</sup>
- Method of installation F: 95 mm<sup>2</sup>
- Method of installation G: 70 mm<sup>2</sup>

### **Voltage drop**

The length of L1 is the decisive factor. Table 19 shows that practical maximal length of this cable is 10 - 30 m (considering reserve, because voltage drop occurs on all elements).



### **There are three possible main obstacles:**

- At L1 the cable cross-section is extremely large indicating the possible need to use e.g., three main power lines, each connecting 10 x INCH Pro as shown on the following figure.
- At L2, L3 and L4 the cables are relatively large, and the junction boxes will need to have double terminal clamps installed for connection of cables. The junction boxes will need to be large enough to also install over-current protection elements.
- It is very likely that dedicated transformer will be required to connect 30 or more INCH Pro charging station, or the total charging current of the cluster will need to be limited.



**CASE 3: POWER CABLES FOR CLUSTER OF 30 INCH IN EXPANDED POINT TO POINT NETWORK**

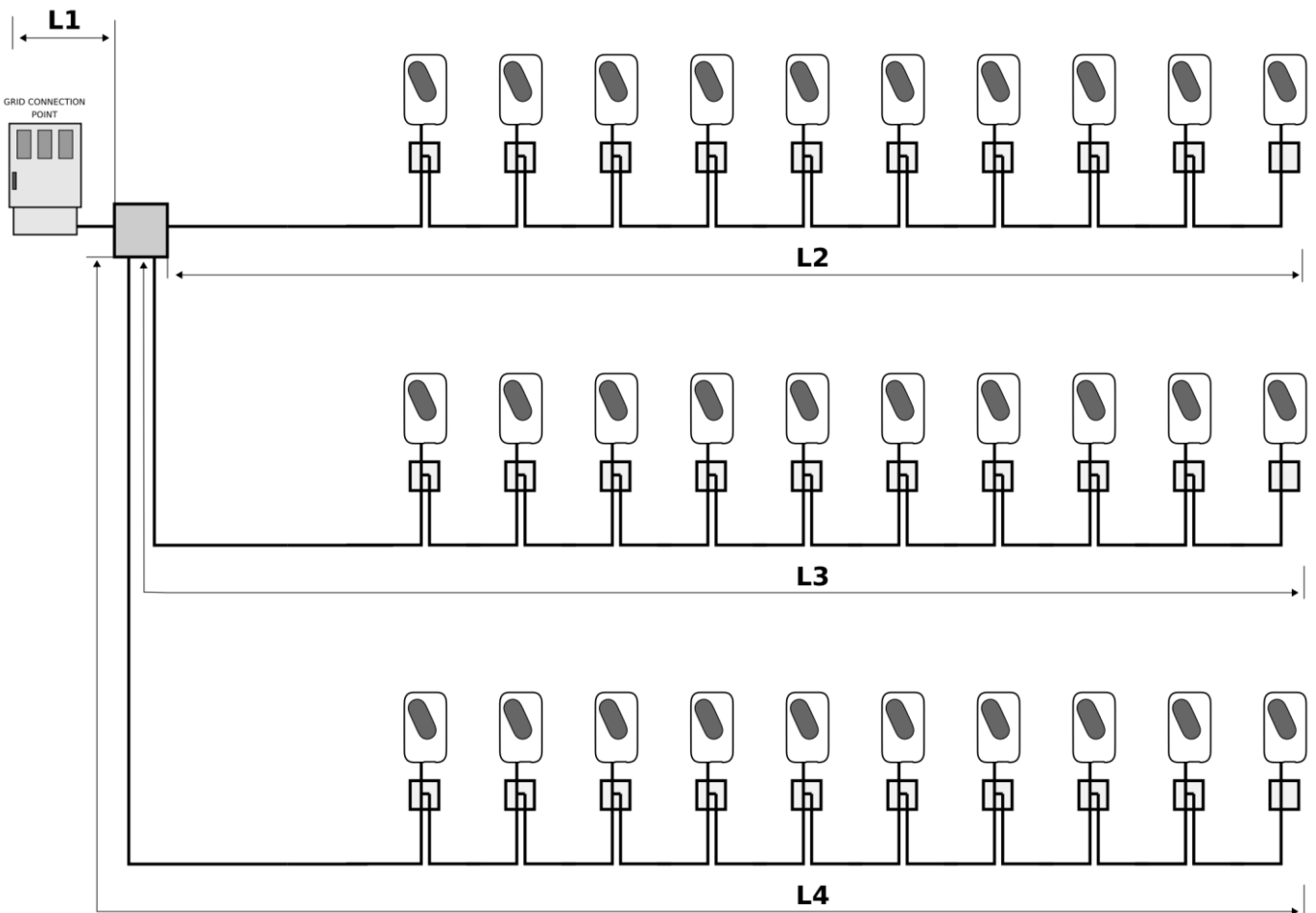

Figure 13: Example of INCH Pro connection – use of double terminal clamps

The figure presented above is showing possible selected configuration, after reviewing Case 1 and 2. It could be more expensive to install three main routes of cables, however using more conductive material (copper) will lower the voltage drop of installation (and with it the power losses).

**CALCULATION OF TOTAL VOLTAGE DROP**

The presented tables include only values of voltage drops in the cables. Voltage drops occur on all elements of electrical system and not only in cables and this should be evaluated or enough reserve when selecting cables cross-section is needed.

The distances play a major role when selecting cluster configuration.

When installing larger number of charging stations, the electrical project of such high power and currents needs to be prepared by licensed electrical designer.

**CASE 4: POWER CABLES FOR CLUSTER OF 30 INCH CONNECTED IN SINGLE-PHASE**

When INCH charging stations are connected in single-phase connection, the connected electric vehicles can charge only over one phase, meaning the highest charging power that is available is 7,36 kW.

In this case, individual charging stations should be connected to different phases to try to distribute single phase loads across all the phases. Usually, cycling of phases is implemented, e.g., first charging station connected to first phase, second charging station connected to second phase, third charging station connected to third phase, fourth charging station connected to first phase and so on.

The load of cluster where charging stations are connected only in single-phase is only one third of the load of cluster with full power. The cable cross-sections can therefore be lower or more charging stations can be installed.

# 5

## CONNECTING CHARGING STATION

Before attaching the installation panel to a wall or a pole, it is essential to consider from which direction the cables will be routed to the charging station, as there is a possibility for each installation method according to the specific installation.

### INSERTION OF CABLES THROUGH THE INSTALLATION PIPE

After the installation pipe is built into the concrete foundation, it is used for cabling and connection of the charging station. The concrete foundation must be left to dry for at least two days before the cables can be inserted in the installation pipe.

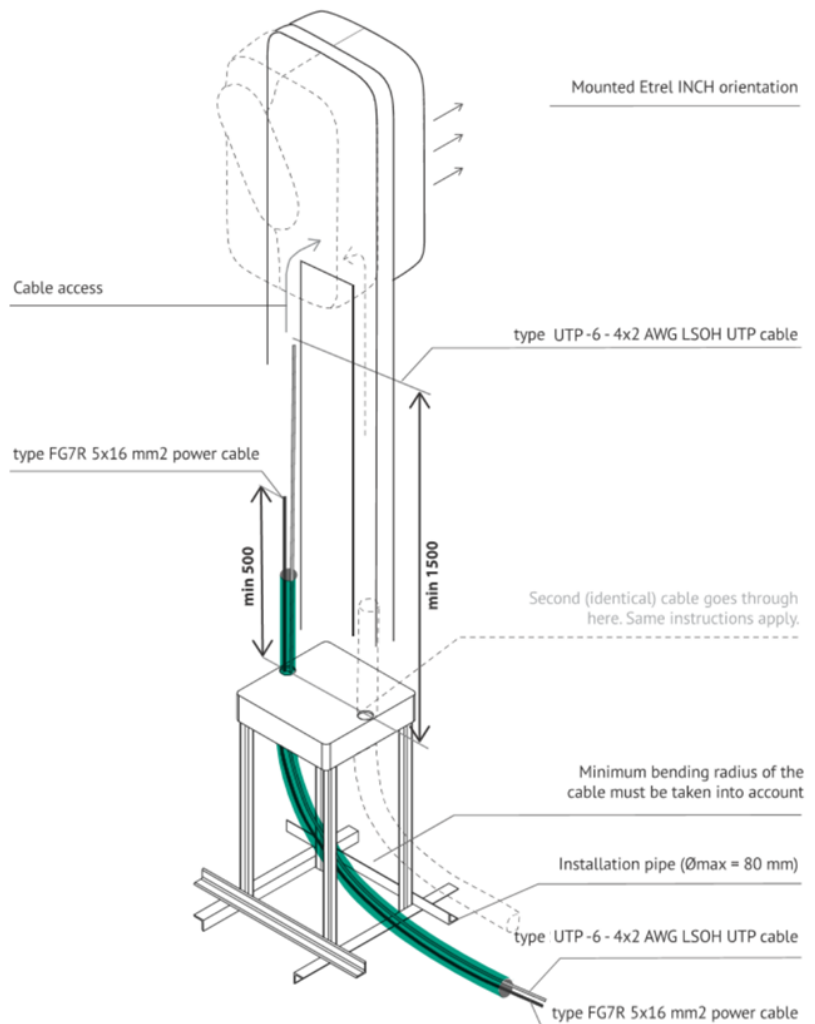

Figure 14: Placing of installation pipe and insertion of cables.

Supply cables are routed through the underground anchoring structure with the use of the installation pipe as shown in the figure above. The exact way of routing the cables depends on the type of the cables used

and their diameter (which is determined in the Electrical installation documentation). When dealing with cables with larger diameters, their bending radius must be considered.

Appropriate length of cables must reach through the upper opening for later connection of the charging station.

## **PREPARATION OF CABLES**

Connection of cables can be done once the mounting bracket is securely fastened either on the wall or on the pole and the charging station holder is attached to the bracket.

1. Pull the power supply cable through the drill hole in the wall if the cables are located on the other side of the wall. If cables are connected to the charging station from above or below make sure that they are long enough.
  - Main cable length available for the installation should be around 40 cm.

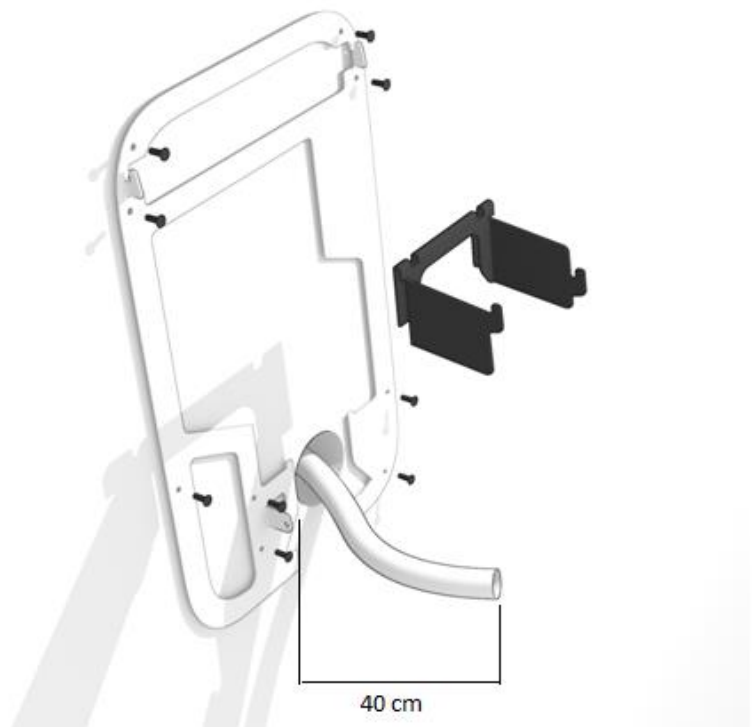

Figure 15: Available length of the main cable

2. On the backside from the charging station screw off the back-maintenance door.

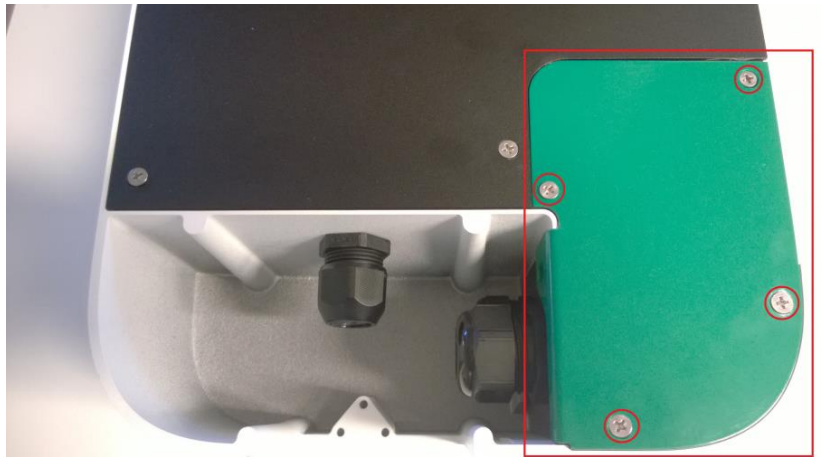

Figure 16: Screws located on the green back maintenance door

**Important:** Key to unlock the key-lock comes with the charging station.

3. Remove the maintenance doors on the side either using hex key or regular key if the enclosure came with the keyhole.



Figure 17: Doors with keylock



Figure 18: Doors with hex screw

4. After the removal of the back-maintenance door un-tighten the screws on the plate with cable glands and remove the plate.

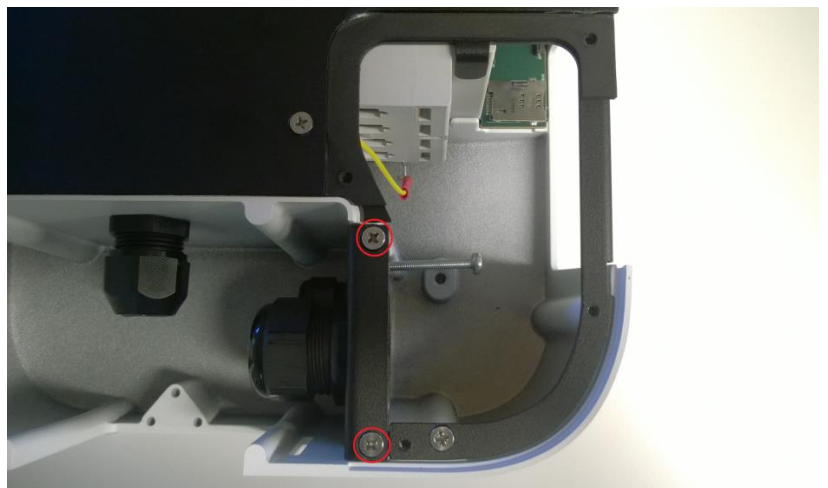

Figure 19: Screws on the cable gland plate



Figure 20: Cable gland plate

**Important:** Diameter of gland rubbers are 1.5 cm for the tighter of the rubbers and 2.1 cm for the looser one.

Bigger cable gland is meant for power supply cables and smaller for the ethernet cable. As is seen from the picture above smaller gland has a plug inside and should be removed if the ethernet UTP cable is used to connect to LAN. Plug is used so that in case when ethernet UTP cable is not used the gland remains closed and prevents water build-up inside the charging station. Inside each gland there is a rubber that makes sure cables are tightly secured inside the gland, that they cannot be removed, and that any liquid or small dust particles cannot enter the charging station interior.

5. Makes sure that the rubber inside the bigger gland is of correct size. For the cable's dimensions up to  $5 \times 6 \text{ mm}^2$  use the tighter rubber which should be already inside the gland by default. For the cables with the  $5 \times 10$  and  $5 \times 16 \text{ mm}^2$  use looser rubber.
  - Diameters of gland rubbers are: 1.5 cm for the tighter and 2.1 cm for the looser one.



Figure 21: Rubbers in cable gland

6. The rubber can be changed after the removal of the gland plastic top (it needs to be unscrewed) and by simply pushing the rubber out of the gland. After the new rubber is inserted into the gland screw the plastic gland top back on.

**Important:** Inserting cables through the gland is easier by loosening the gland screw cap by turning it counter-clockwise.

7. Proceed with the preparation of cables. First the cable jacket of power supply cables needs to be removed. Around 15 cm should be removed so that the wires lengths are sufficient to connect them to the elements inside the charging station.
8. Pull the power supply cable through the gland. About 15 cm of power supply cable should be pulled to the other side of the gland. About 2 cm of cable jackets should be put through the cable gland as well. This will make cable manipulations inside the charging station easier.  
  
Make sure that the cable is fastened securely with the gland so that it cannot be pulled out. The gland can be tightened by turning the plastic gland top in clockwise direction.
9. Length of the skinned cable through the gland should be:
  - All phase cables and neutral: 12 cm
  - Ethernet cable: 17 cm
  - Ground cable: 9 cm

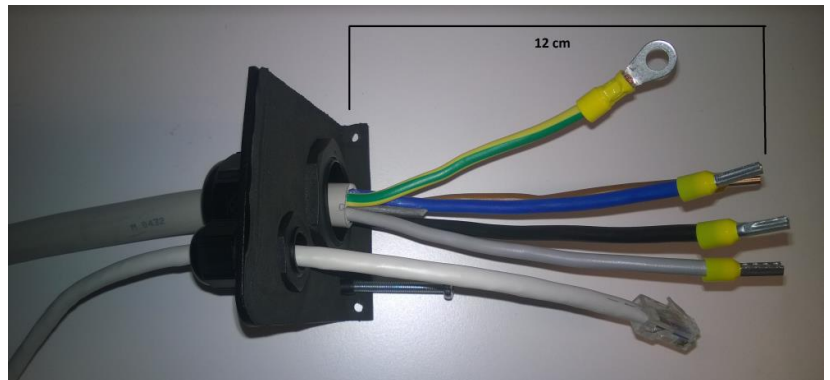

Figure 22: Power supply cable pulled through the plastic gland – side view



Figure 23: Power supply cable pulled through the gland – front view

10. Grounding wire should be around 5 cm shorter in comparison to other wires. If needed, shorten it and after that remove the wire insulation from all the wires using special insulation stripping pliers.

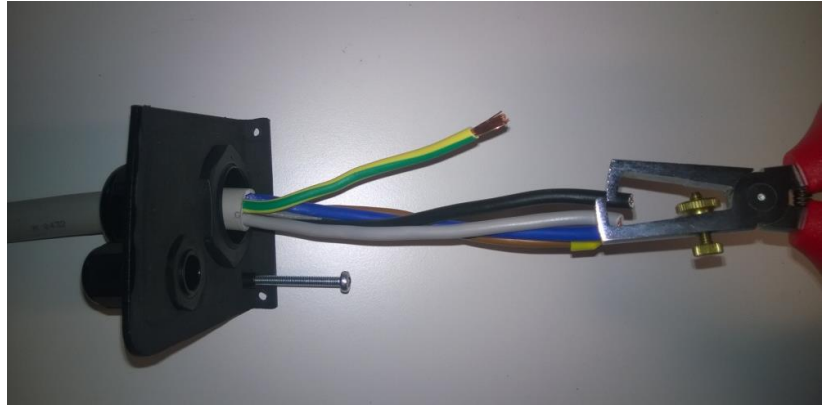

Figure 24: Removing the wire insulation

11. Once all the wires are stripped of wire insulation attach on the end of the wires cable ferrules so that wires can connect to RCD or overcurrent protection and squeeze them with the pliers.



Figure 25: Cable ferrule for wires other than ground wire



Figure 26: Cable ferrule for the grounding wire

**Important:** Make sure that the cables are inserted into the correct slots.



Figure 27: Squeezing the ferrules of the wiring

12. Now that the power supply wires are ready, prepare the ethernet UTP cable in the same manner. First remove the UTP gland filler. Filler is part of the gland rubber. After removal of the gland cap by unscrewing it in counter-clockwise direction, push the filler out. Insert the rubber back into the gland as it will likely come out together with the filler.





Figure 28: UTP gland rubber with filler



Figure 29: Removed filler from the gland rubber

**Important:** UTP cable used should be UTP Category 6, 4x2 AWG LSOH

13. Insert the UTP cable through the gland and remove the cable jacket from the cable. About 20 cm of UTP cable should be put out of the gland.
  - Cable jacket can also be removed before putting the cable through the gland.

**Important:** Make sure that each wire is in its own slot of the connector.

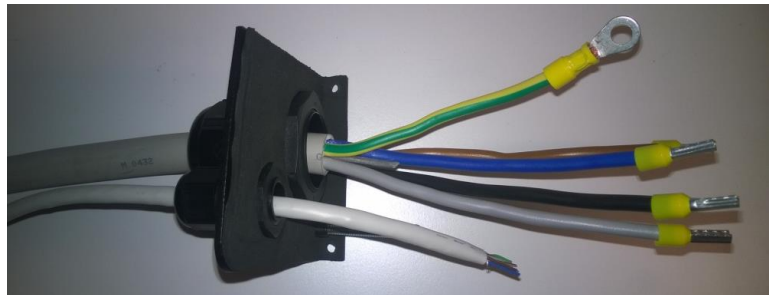

Figure 30: Ethernet cable with the removed cable jacket pulled through the UTP gland

14. After the cable is through the gland put the UTP plug on the UTP cable without cable jacket.



Figure 31: UTP cable plug

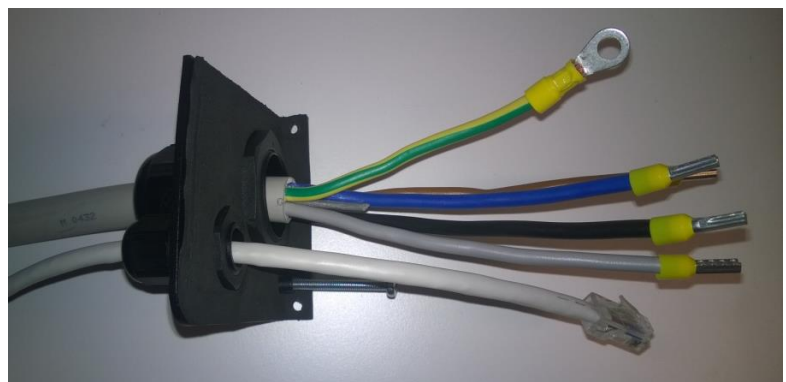

Figure 32: UTP cable with inserted connector

## **MOUNTING OF THE CHARGING STATION AND INSTALLATION OF CABLES**

Once the cables had been prepared, the installation of cables into the charging station can start.

1. Mount the station on the holder that is already attached to the already installed bracket on the wall. The holder is strong enough to hold the charging station during the installation of cables.



Figure 33: Charging station mounted on the holder - front view



Figure 34: Charging station mounted on the holder - side view

2. Place the gland plate in its position so that the plate holes are in line with holes of the enclosure.
  - Make sure that cables are long enough so that they could be connected with appropriate connection.

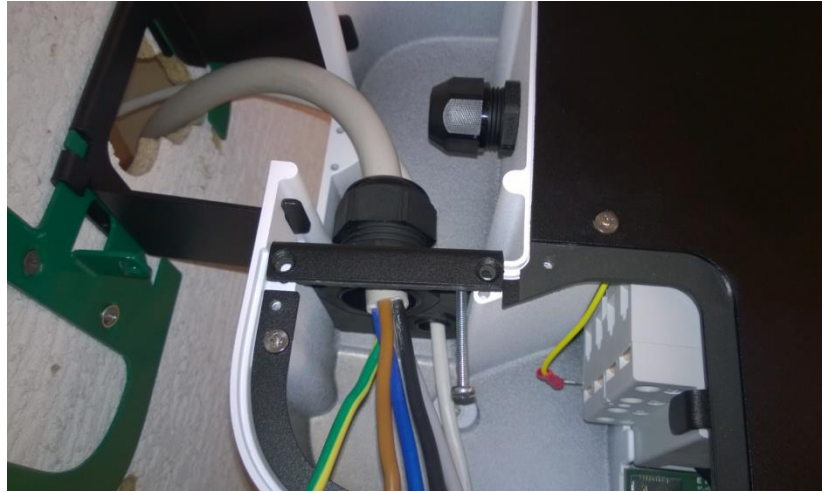

Figure 35: Cable gland plate positioned in the appropriate spot

3. Insert the screws in the cable gland plate holes and tighten them so that the cable gland plate is secured in its location. Use the regular cross screwdriver.

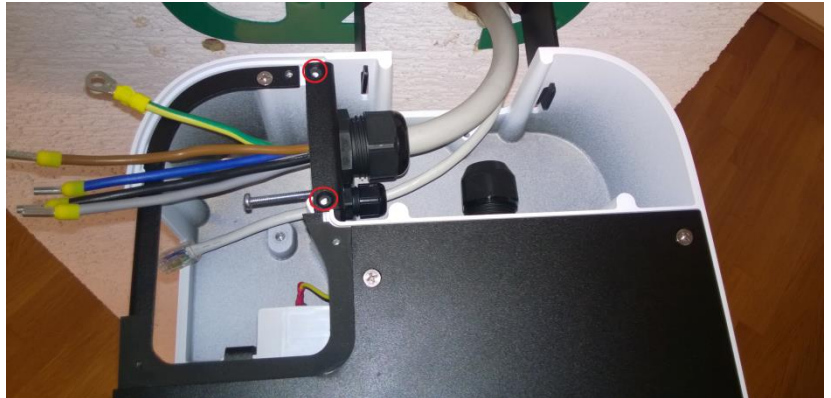

Figure 36: Red colour marks the holes where screws need to be inserted

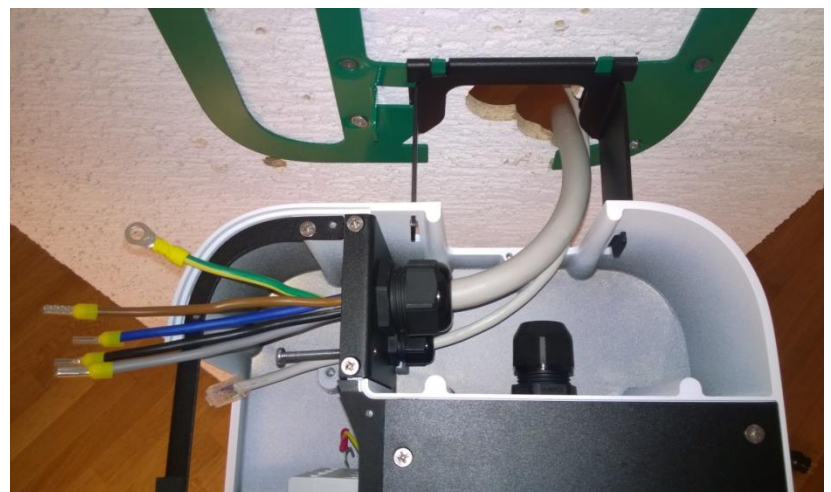

Figure 37: Screwed in screws that hold the cable gland plate in place

4. Next action is to secure the ground wire to the enclosure to ground it. Ground wire (yellow and green) should be secured with the screw in the hole that is part of the enclosure.



Figure 38: Ground wire secured to the enclosure using the screw

5. Next step is to connect cables to protection element or MID meter. Connection of all the elements is practically the same. The procedure described below is for connection of RCD, however the procedure can be followed for other connection elements as well. The only difference is that the RCD element needs additional protection wire.
6. There is a sticker on main connection element showing the correct designation of phases and neutral conductor. Remove the sticker and make sure that screws inside the RCD/overcurrent/MID in which wires will be connected are unscrewed.



Figure 39: Check that the marked screws are unscrewed so that wires can be inserted

7. Only for RCD element: Insert the additional protection wire to enable RCD trip into the fourth slot (Neutral) like it is shown on the figure below – the neutral slot is the closest to the enclosure.

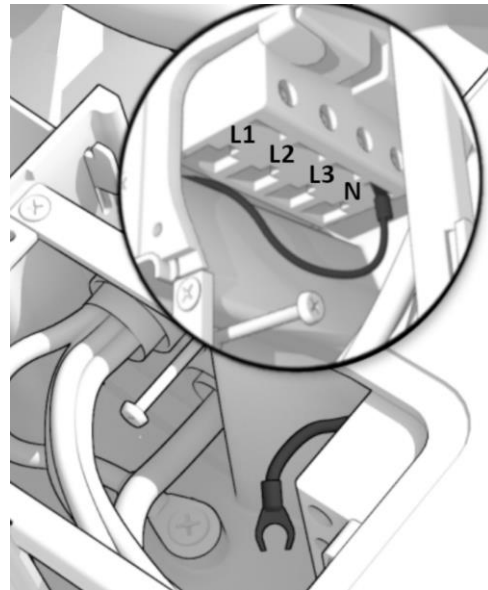

**Figure 40: Protection to enable RCD trip inserted into the slot of neutral**

8. Now insert all the wires into the RCD/overcurrent/MID unit. Order of the wires and how they are connected is important. In the top connector, which is phase one (L1) of the charging station, wire that will be used to charge one phase EVs should be connected. It is advisable that least loaded phase is used.

The order of second and third phase is more important when charging station is part of the cluster. Bottom connector should be used to connect neutral wire (N).

9. After connecting the wires, the screws should be tightened so that the wires cannot be unplugged. Under IEC rules, correct order and colour of conductors is described below. In specific countries the colour of conductors can be different.

### **Three-phase connection**

Phase 1: Brown, Phase 2: Black, Phase 3: Grey, Neutral: Blue.

The order should be followed from top down. At the top is Phase 1 (brown) conductor and the conductor closest to the enclosure is Neutral (blue).

The order of three phase conductors can be different in case of wiring of clusters. To provide better spread of the load across all three phases in case of charging of vehicles, that can only charge in single-phase, the conductors of individual charging stations can be switched while still retaining the phase sequence.

Possible options, wiring from top to bottom:

- Charger 1: Phase 1 – Phase 2 – Phase 3 – Neutral
- Charger 2: Phase 2 – Phase 3 – Phase 1 – Neutral
- Charger 3: Phase 3 – Phase 1 – Phase 2 – Neutral

### Single phase connection

One of the phase conductors should be connected to first phase of the connection element (on top). The neutral (blue) should be connected at bottom, the closest position to the enclosure.

In some countries the colour of the conductors can be different.

### Special single phase configuration case, MID meter with RCD

In case of a single-phase configuration of INCH, with single-phase MID meter and with single-phase RCD element, the power connection is made using the MID meter as indicated on the labels.

Phase conductor is inserted in the top slot (left side of the MID meter) and neutral conductor is inserted in the second slot of the MID meter (right side of the meter). In addition, the red wire needs to be inserted in the neutral pole of the RCD, at the bottom (right side of the RCD). This wire enables tripping of the RCD.

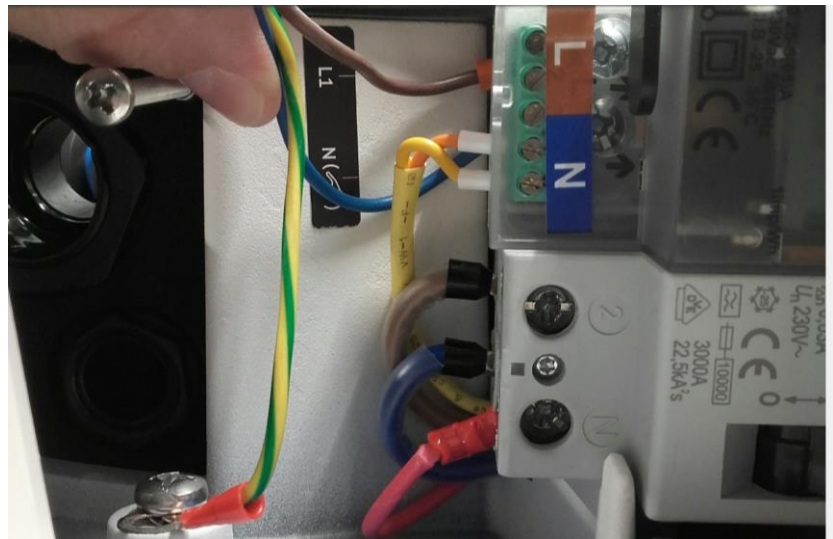

Figure 41: Wire to enable RCD trip is inserted into the slot of neutral

10. Connect the ethernet UTP cable into an ethernet connector next to the protection element.



Figure 42: Ethernet UTP cable connected to the connector next to the protection element (RCD in this case)

11. Attach the back-maintenance doors back onto the enclosure and use the screw to secure it to the location.



Figure 43: Side view of the reattached back maintenance door



Figure 44: Secure the back-maintenance doors with screws

12. Remove the charging station off the holder and remove the holder from the bracket. While doing this make sure that you hold the charging station carefully as it will not be supported by the holder anymore.



Figure 45: Charging station is removed from the holder



Figure 46: Holder is removed

13. If using charging station with cable for charging, cable holder must be attached when the charging station is removed from the station holder. There is not enough space available to do it while the charging station sits on top of the holder. To attach enclosure to the plate, align the cable holder holes with holes on the plate.

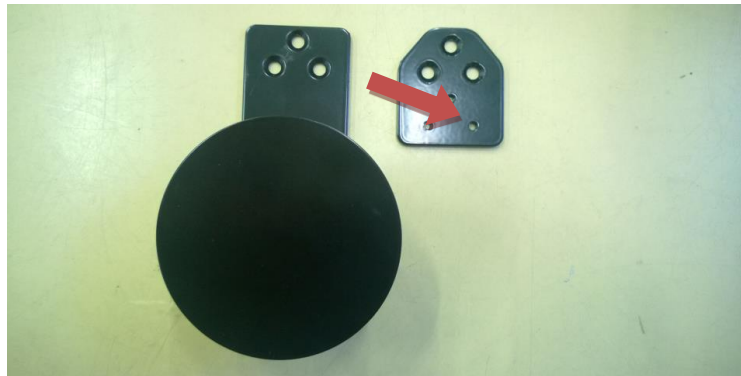

Figure 47: Cover the holes of the metal hook with the holes on the plate that is located on the enclosure as it is shown on the figure



Figure 48: Hook with circle on top of the plate that is located on the bottom of the enclosure



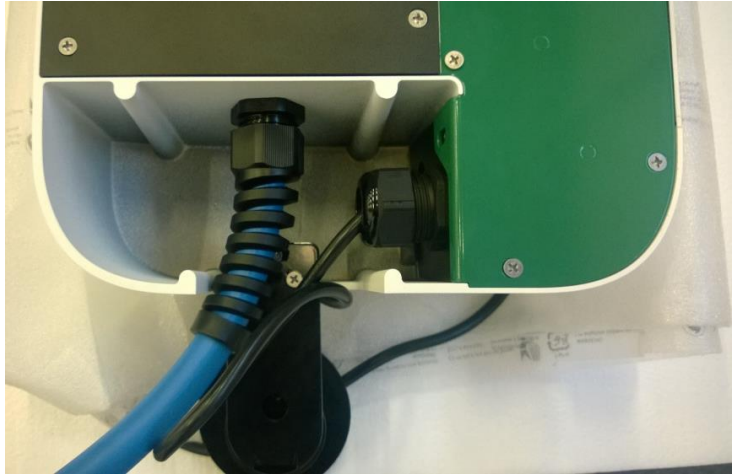

Figure 49: Installed metallic cable holder



Figure 50: Charging station with the installed small metal circle where magnetic cable hand can be attached to



Figure 51: Charging station with installed big metal circle where magnetic cable hand can be attached to

14. Attach the charging station to the wall bracket. First attach it to the top hooks and gently push it to the wall.



Figure 52: Attach the charging station to the top hooks and push it to the wall

15. Tighten the screw until it is completely fastened and charging station will be completely secured to the wall.



Figure 53: Tighten the screw shown

16. Last step is to secure the side doors using the hex key or regular key if the charging station came with it. Key should have come together with the station. While pushing the maintenance doors tighten the screw or lock the doors using the key.



Figure 54: Attach the side doors to the enclosure



Figure 55: Secure maintenance doors enclosure using hex key



Figure 56: Charging station with short cable

Figure 57: Charging station with long cable

## 6

**ELECTRICAL MEASUREMENTS**

Electrical measurements must be performed by licensed electrician and must be in accordance with requirements set in national legislation. In this chapter only information on specifics of some of the electrical measurements is given.

**EARTHING CONDUCTOR CONTINUITY TEST**

Continuity measurement should be performed for protective conductors, including conductors in the main and additional equipotential. Measurement will have to be made between PE terminal of charging station's socket and inlet PE conductor. If the charging station is equipped with cable, the measurement should be made between PE conductor of the cable plug and inlet PE conductor.

**WARNING!**

**Before carrying out the measurements, switch off the charging station or main power supply.**

Continuity measurement should be made with a current greater than or equal to 200 mA. The open circuit test voltage should be between 4 and 24V (AC or DC). The measuring range shall include values 0,2 Ohm to 2 Ohm and the maximum percentage operating uncertainty within this measuring range shall not exceed +- 30 %. The resolution of digital equipment shall be at least 0.1 Ohm.

The use of instrument, with option of measuring at higher current than 200 mA increases the accuracy of the measurement. The method of measurement is shown in the figure:

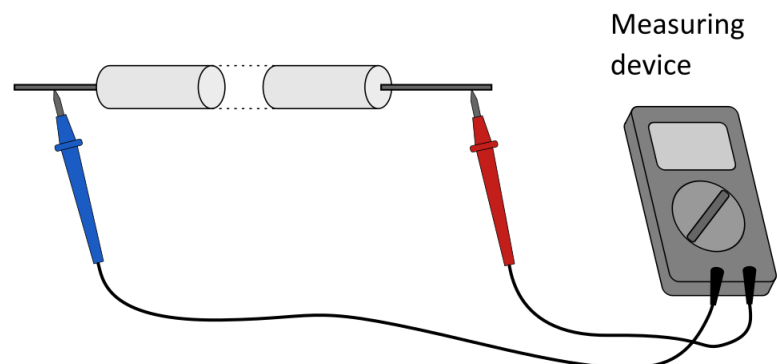

Figure 58: Continuity measurement

Continuity of the wire is considered to be met if the connection resistance does not exceed the value of 2  $\Omega$ .

## INSULATION RESISTANCE MEASUREMENT

Measurements of the insulation resistance of electric cables are performed between active conductors and between active conductors and the protective conductor connected to the earthing system.

Insulation resistance, measured at a test voltage of 250 V d. c. is satisfactory if its value is not less than 1 MΩ.

Table 20: Insulation resistance measurement conditions

Nominal voltage	Test voltage	Insulation resistance
230/400 V, up to 500 V (Applicable to all charging station from Etrel)	250 V d. c.	≥ 1 MΩ



**BECAUSE THE CHARGING STATION HAS VARISTORS INSTALLED, THEY MAY AFFECT THE MEASUREMENT RESULT OR MAY BE DAMAGED.**

**THE TEST VOLTAGE FOR THIS CIRCUIT SHOULD BE SET TO 250 V DC. THE MEASURED INSULATION RESISTANCE SHOULD BE AT LEAST 1 MΩ.**

**TO PERFORM THE INSULATION RESISTANCE TEST, THE POWER SUPPLY MUST BE DISCONNECTED.**

Explanation:

*Please follow the procedure as stated in the standard IEC 60364-6, which is stating that all current-using equipment must be disconnected before the test of insulation resistance, Chapter 6.4.3.3. To perform the insulation resistance test, the power supply must be disconnected.*

*As specified in IEC 60364-6, 6.4.3.3 Insulation resistance of the electrical installation:*

*Because the charging station has varistors installed, they may affect the measurement result or may be damaged. It is not possible to disconnect the varistors and the test voltage for this circuit should be set to 250 V d. c. and the measured insulation resistance should be at least 1 MΩ.*

*The standard values of insulation resistance measurement, shown in the table below **are not applicable**.*

Table 21: Standard values of insulation resistance measurement are not applicable

Nominal voltage [V]	Test voltage d. c. [V]	Insulation resistance [MΩ]
SELV and PELV	250	0,5
Up to 500 V including FELV	500	1
Above 500 V	1000	1

## **RCD TEST**

The effectiveness of the automatic disconnection of the power supply by RCD devices should be checked with the use of appropriate test equipment, confirming that the relevant requirements are met and considering the operating characteristics of the device. The effectiveness of the protection measure can be considered satisfied if the trip occurs at a certain value of the leakage current and within a certain time.

Each socket of the charging station should always be protected with an individual RCD, which can be part of device or part of the installation.

The standard IEC 61851-1 specifies that this RCD should have sensitivity of 30 mA and be of Type B or equivalent. The possible equivalent is the use of RCD of Type A with additional DC leakage sensor.

The effectiveness of the automatic disconnection of the power supply by RCD devices should be checked with the use of appropriate test equipment, confirming that the relevant requirements are met and taking into account the operating characteristics of the device.

The effectiveness of the protection measure can be considered satisfied if the trip occurs at a certain value of the leakage current and within a certain time.

**Table 22: Type AC and A residual current circuit breakers without built-in overcurrent protection - normalized switching time values**

<b>Normalized tripping time values for residual current <math>I_{\Delta n}</math></b>				
<b>RCD Type A General purpose</b>	Testing current	$I_{\Delta n}$	$2 I_{\Delta n}$	$\geq 5 I_{\Delta n}$
	Maximum tripping times	0.3 s	0.15 s	0.04 s

**Table 23: Type B RCDs - normalized tripping time values for residual currents in rectifier circuits and for smoothed residual current**

<b>Normalized tripping time values for residual current <math>I_{\Delta n}</math></b>				
<b>RCD Type B General purpose</b>	Testing current	$2 I_{\Delta n}$	$4 I_{\Delta n}$	$\geq 10 I_{\Delta n}$
	Maximum tripping times	0.3 s	0.15 s	0.04 s

## MEASUREMENTS OF THE EFFECTIVENESS OF PROTECTION AGAINST ELECTRIC SHOCK

In the case of TN systems, the effectiveness of protective measures in the event of damage by tripping the power supply is checked by:

- a) measurement of fault loop impedance,
- b) verification of the characteristics and/or effectiveness of the associated protection.

For the TN system, the following condition should be met:

$$Z_S \times I_a \leq U_o$$

Where:

- $Z_S$  is the fault loop impedance,
- $I_a$  is a current that causes an automatic power cut-off within the time specified in the table below,
- $U_o$  is the rated AC or DC voltage with respect to earth.

Table 24: Maximum switch-off times

System	120 V < $U_o$ ≤ 230V	230 V < $U_o$ ≤ 400V
	AC	AC
TN	0,4 s	0,2 s
TT	0,2 s	0,07 s

In TN systems, for distribution circuits and circuits with a rated current above 32 A, the permissible maximum time of switching off is 5 s.

## **EARTH ELECTRODE RESISTANCE MEASUREMENT**

Measuring of the resistance of an earth electrode shall be made by an appropriate method. Various methods exist and none of them is ideal, as they all have advantages and disadvantages. The methods, described below, are proposed in standard IEC 60364-6.

Other methods may be used if allowed by national legislation. The value of the measured resistance shall be less than 100 mΩ.

An example is a method of measurement using two auxiliary earth electrodes, Method C1. Where the location of the installation is such that it is not possible in practice to provide the two auxiliary earth electrodes, measurement of the earth fault loop impedance according to Methods C2 or C3 will give an acceptable approximate value.

### **MEASUREMENT OF EARTH ELECTRODE RESISTANCE USING AN EARTH ELECTRODE TEST INSTRUMENT (METHOD C1)**

An alternating current of a steady value is passed between the disconnected earth electrode, E, and a temporary auxiliary earth electrode, H, placed at a distance from E such that the resistance areas of the two electrodes do not overlap.

A second temporary probe electrode, S, which may be a metal spike driven into the ground, is then inserted half-way between E and H, and the voltage drop between E and S is measured. In most cases S should be placed at approximately 20 m from E and H. The electrodes may be arranged in a linear formation (see following figure, a. case) or triangular formation (see following figure, b. case) to suit available space.

The resistance of the earth electrode is then the voltage between E and S, divided by the current flowing between E and H, provided there is no overlap of the resistance areas.

To check that the resistance of the earth electrode is a true value, two further readings are taken with the second electrode, S, moved approximately 10 % of the linear distance between E and H from the original position. If the three results are substantially in agreement, the mean of the three readings is taken as the resistance of the earth electrode E. If there is no such agreement, the tests are repeated with the distance between E and H increased.



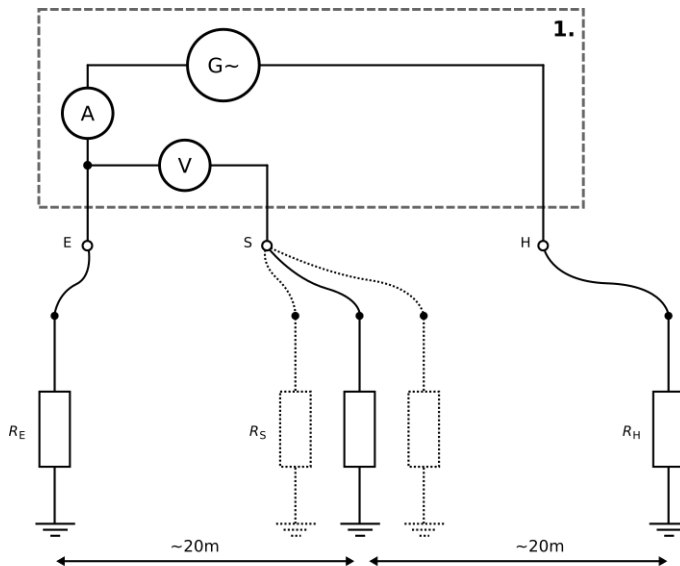

a) Electrodes arranged in linear formation

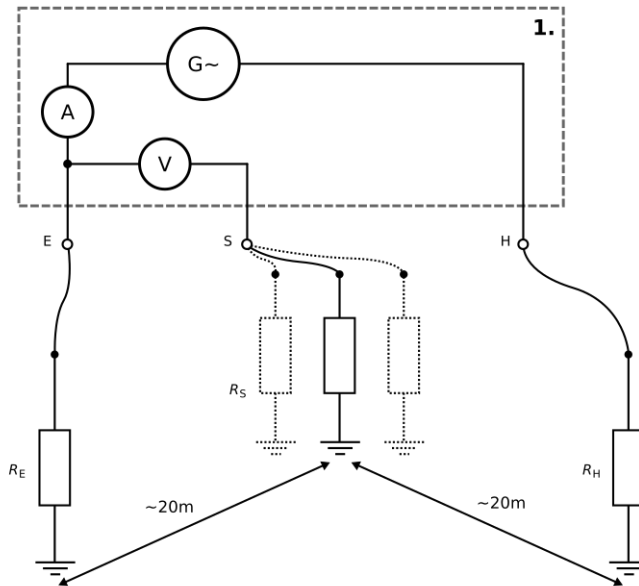

b) Electrodes arranged in triangular formation

**Key**

- 1. Earth electrode test instrument according to IEC 61557-5
- $R_E$  Earth electrode resistance
- $R_S$  Temporary probe electrode resistance (voltage)
- $R_H$  Temporary auxiliary probe earth electrode resistance (current)

Figure 59. Measurements of the earth electrode resistance

**MEASUREMENT OF EARTH ELECTRODE RESISTANCE USING A FAULT LOOP IMPEDANCE TEST INSTRUMENT (METHOD C2)**

Measurement of the earth fault loop impedance at the origin of the electrical installation may be carried out with a test instrument according to IEC 61557-3.

The test should be performed on the live side of the main switch with the supply to the installation switched OFF and with the earthing conductor temporarily disconnected from the main earthing terminal (MET).

The test instrument should be set to a range appropriate for the value of earth fault loop impedance likely to be expected for a given system earthing arrangement (typically in the region of 0 Ω to 20 Ω).

The test instrument should be connected as shown in the following figure. Where any doubt exists, the instrument should be connected as described in the manufacturer’s instructions.

Only a small proportion of the measured earth fault loop impedance is derived from those parts of the loop other than the electrode and so the result obtained from this test can be taken as a reasonable approximation of the earth electrode resistance.

**It is important that the earthing conductor is reconnected to the MET of the installation before the supply is reinstated.**

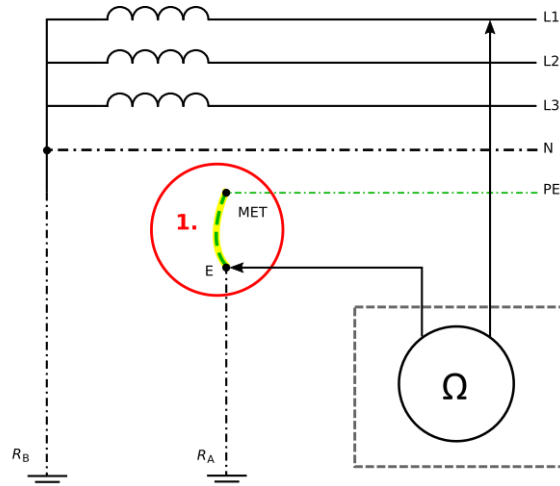

1. Earthing conductor temporarily disconnected from the main earthing terminal (MET).

**Figure 60. Measurement of the earth electrode resistance using an earth fault loop impedance test instrument**

### MEASUREMENT OF EARTH ELECTRODE RESISTANCE USING CURRENT CLAMPS (METHOD C3)

With reference to the following figure the first clamp induces a measuring voltage  $U$  into the loop, the second clamp measures the current  $I$  within the loop. The loop resistance is calculated by dividing the voltage  $U$  by the current  $I$ .

As the resulting value of parallel resistances  $R_1 \dots R_n$  is normally negligible, the unknown resistance is equal to, or slightly lower than, the measured loop resistance.

The voltage and current coils may be in individual clamps separately connected to an instrument or in a single combined clamp.

This method is directly applicable to TN systems and within meshed earthing of TT systems.

In TT systems, where only the unknown earth connection is available, the loop can be closed by a temporary connection between earth electrode and neutral conductor (quasi-TN system) during measurement.

To avoid possible risks due to currents caused by potential differences between neutral and earth, the system should be switched off during connection and disconnection. It should be noted that the values of resistance obtained using Method C3 will typically be higher than those obtained using Method C1 because of the earth loop measurement.

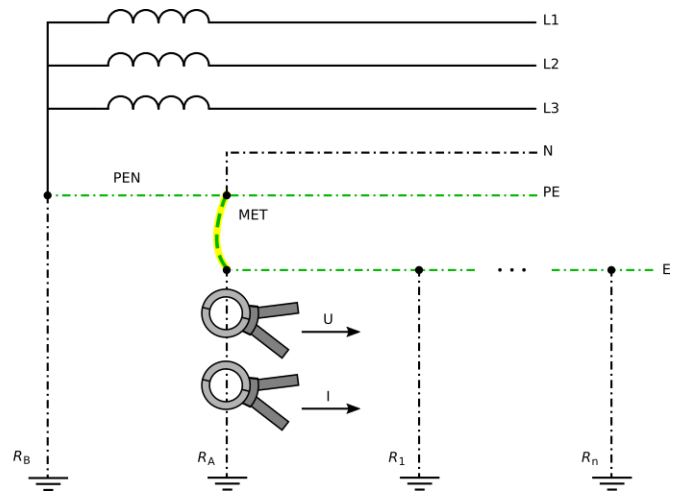

Figure 61. Measurement of earth electrode resistance using current clamps

## 2-POINT (DEAD EARTH) METHOD

In areas where driving ground rods may be impractical, the two-point method can be used. With this method, the resistance of two electrodes in a series is measured by connecting the P1 and C1 terminals to the ground electrode under test; P2 and C2 connect to a separate all-metallic grounding point (like a water pipe or building steel).

The dead earth method is the simplest way to obtain a ground resistance reading but is not as accurate as the three-point method and should only be used as a last resort, it is most effective for quickly testing the connections and conductors between connection points.

# 7

## OPERATION AND CHARGING PROCEDURE

INCH charging station can be controlled locally or remotely, through web interface, or through charging station management system.

### FIRST POWER UP



**Before starting the station, it is absolutely necessary to read this manual and the technical specification of the device.**

- Connect charging station to the power supply in the electrical cabinet. Installation feeder should be turned on.
- When the charging station has either overcurrent or RCD protection installed, check whether the protection element is in ON position.
- Charging station is powered up automatically when it is connected to the electricity.
- When the charging station is power up for the first time it can take several minutes for station to get ready to start using it to charge EV.

### STATUS OF LED

LED colour	State	LED action	Sub-state
Green	- Booting - OK - Available	Steady green	Booting
		Steady green	Connector available
		Blink green slow	Preparing for charging
		Blink green fast	Waiting for vehicle
Blue	- Charging	Blink blue	Charging
		Steady blue	Charging ended
		Steady blue	Charging paused (by EV or by EVSE)
Red	- Fault - Unavailable	Blink red	Fault
		Steady red	Connector unavailable

## **SETTING OF MAXIMAL CHARGING CURRENT**

Max power is set by the installer based on the grid capabilities where charging station is installed. If there is need to change it, please set the current limitation in the charging station's web interface before starting the first charging session.

## **FIRST CHARGING SESSION**

When the charging station is ready to be used, follow the procedures described on the LCD screen. Two charging modes can be selected:

- Fast charging (default)
- Interactive charging

Charging modes are chosen during the charging session.

During the fast-charging EV will be charged with the max available charging power as fast as possible. Max power is set by the installer based on the grid capabilities where charging station is installed.

When Interactive charging is chosen the charging schedule will be modified based on the inserted departure time. If it is not inserted, it will be based on the default value. Historic data are recorded from the first charging session onward and can only be used after the first charging session is finished.

More charging session means more accurate session prognosis and schedules. Charging schedule will be created based on electricity prices, other loads, and PV production to make sure EV is charged in appropriate time while taking in consideration other constraints.

## **CHARGING PROCEDURE**

### **STEP 1: WAKE**

In normal conditions, the charging station's LCD screen will likely be in the screen saver mode. Charging station can be woken up by simply tapping the screen.

Screen saver mode can be chosen in the charging station's web interface.

Three options of display setting exist:

- Turned on all the time,
- blinking or
- turned off until touched.

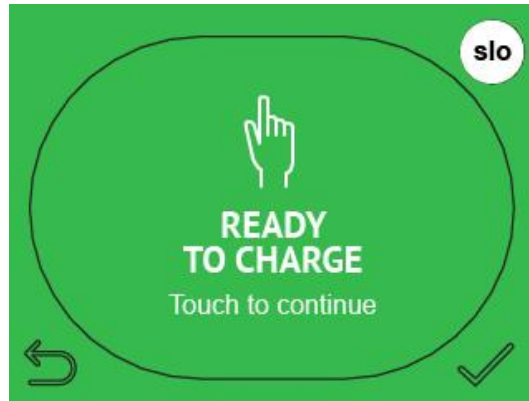

Figure 62: Screen saver

## STEP 2: AUTHORISATION

Depending on the charging station authentication mode chosen different screens will be shown that will need different actions from user to continue with the charging session.

What authorization is allowed can be setup in the charging station's web interface Configuration menu.

### Plug and charge mode

In the plug and charge mode message is shown to insert the cable and start the charging session.

### Needed authentication

If authentication is needed, select the type of authentication that will be used to authorize and continue with the charging session.

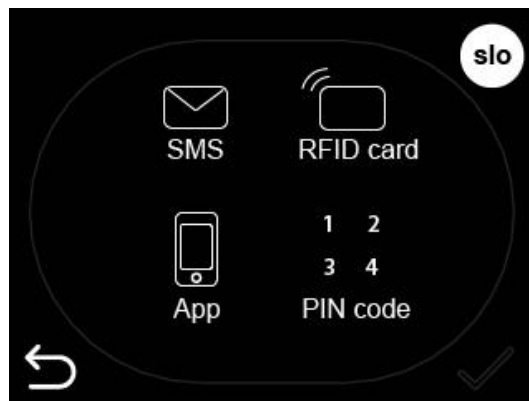

Figure 63: Choose authorisation method

a. Insert PIN code

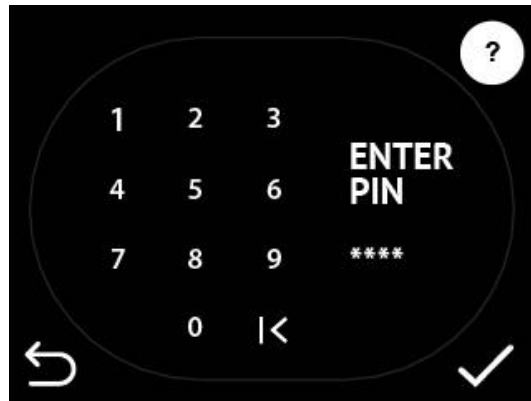

Figure 64: Insert PIN code

b. Use mobile app to authenticate

Either type the code of the station to the mobile app or scan QR code with mobile.

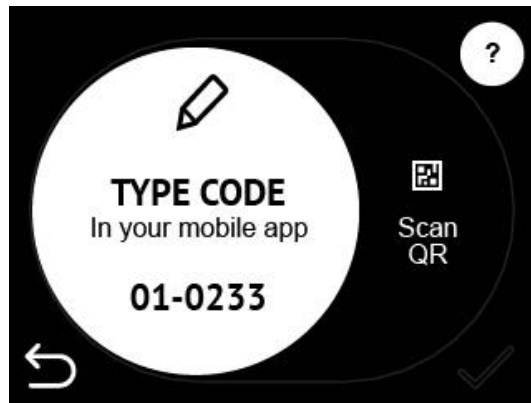

Figure 65: Insert charging station's EVSE code



Figure 66: Scan QR code

c. Swipe RFID card

By simply swiping the RFID card below the LCD touch screen where the RFID module is installed, the authorization on the charging station is made and the charging session can begin.

### STEP 3: CONNECTING THE CABLE

After the successful authorization, the screen with the description to connect the cable is shown.

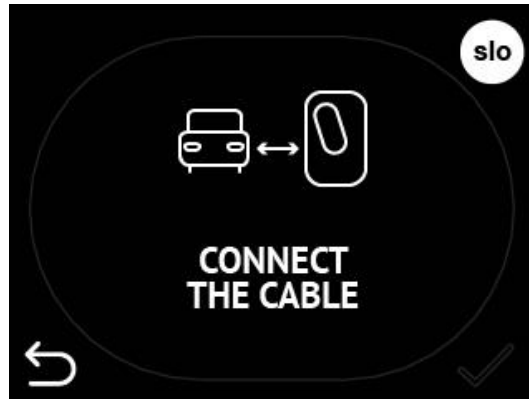

Figure 67: Connect the cable to charging station and EV

If the cable is connected before the authorization this screen will be left out and after the authorization next screen “Waiting for vehicle to respond” will be shown. When the cable is connected charging station will start charging as soon as EV responds.



Figure 68: Charging station is waiting for EV to responds and starts charging

### STEP 4: DEPARTURE TIME INPUT

As soon as the charging session begins, the screen to input departure time is shown. Presented departure time is the one calculated by the charging station based on previous charging habits. The presented departure time can be changed to make sure that the EV is charged.

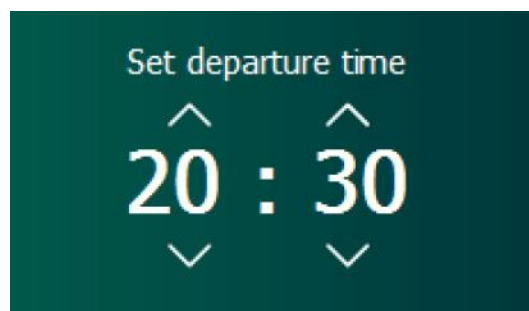

Figure 69: Set the departure time



When the departure time is set, or default setting is let through charging data will be shown. What charging information is presented depends on the settings of web interface.



Figure 70: Example of shown energy on the LCD screen

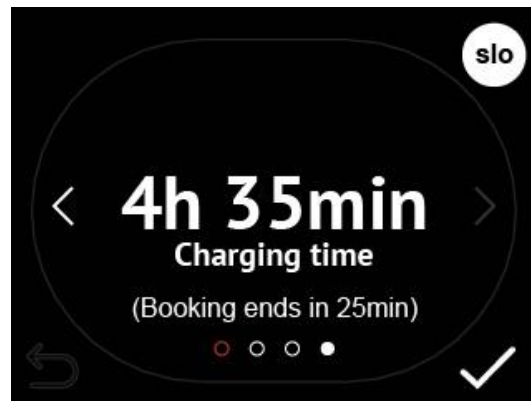

Figure 71: Display of charging time

## CHECK STATUS OF THE CHARGING STATION

In the web interface the information of the current session can be seen. The departure time can be changed using web interface by pressing the »Interactive mode« button.

## STOP THE CHARGING SESSION

Charging station can be stopped locally or remotely.

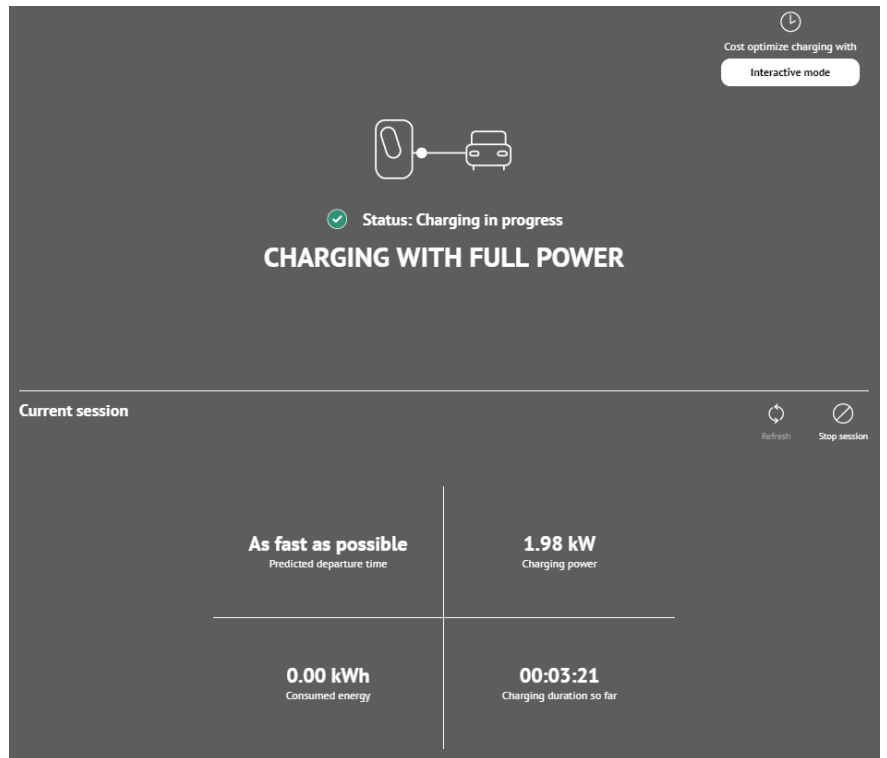

Figure 72: Display charging data in web interface

#### LOCALLY

The charging session can be ended by using the same authorization method as for starting the session (using an RFID card, mobile application, PIN code) and removing the plug from the charging socket or, in the case of a station configuration without authorization, by simply removing the plug from the charging socket.

#### REMOTELY

Stop of charging session can be done remotely with the use of web interface.

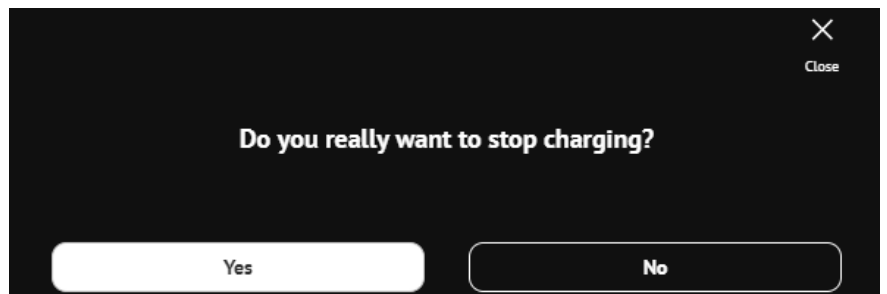

Figure 73: Confirmation window in the web interface for ending the charging session

## CONTACT INFORMATION

### TECHNICAL SUPPORT DEPARTMENT

e-mail: [support@etrel.com](mailto:support@etrel.com)

phone: +386 1 601 0127

### CUSTOMER SUPPORT DEPARTMENT

e-mail: [sales@etrel.com](mailto:sales@etrel.com)

phone: +386 1 601 0175

### AUTHORISED SERVICE CENTRES

e-mail: [support@etrel.com](mailto:support@etrel.com)

phone: +386 1 601 0075

**Etrel d.o.o.**

**Pod jelšami 6**

**1290 Grosuplje**

**Slovenia**

**EU**

**[www.etrel.si](http://www.etrel.si)**