

**ETREL**

a Landis+Gyr company

# **ELECTRIC VEHICLE CHARGING STATION**

## **ETREL INCH**

### **USER MANUAL**

Document version: 1.9

Document date: 11. 4. 2023



# TABLE OF CONTENTS

<b>1</b>	<b>FOREWORD</b> .....	<b>1</b>
	General Information .....	2
	Safety Information .....	4
	Operation .....	4
	Irregularity or Interference at Operation .....	5
	Maintenance .....	5
	Fire Safety Measures .....	5
	Firefighting Measures .....	6
	Environmental Safety Measures.....	7
	Correct Disposal of this Product and Sustainability.....	7
	Compliance.....	8
	Simplified EU Declaration of Conformity.....	8
	Tested Compliance with Standards.....	8
	Safety Risk Analysis .....	9
	Design Considerations .....	11
	Licenses .....	11
<b>2</b>	<b>PRODUCT DESCRIPTION</b> .....	<b>13</b>
	Basic Functionalities.....	13
	Base Specifications.....	14
	Content, Optional and Extra Equipment.....	16
	Identify Product Variant.....	18
	Circuit Diagram .....	19
<b>3</b>	<b>OPERATION AND CHARGING PROCEDURE</b> .....	<b>20</b>
	First Power up .....	20
	Setting of Maximal Charging Current .....	21
	First Charging Session .....	21
	Charging Procedure .....	21
	Check Status of the Charging Station.....	25
	Stop the Charging Session.....	25
<b>4</b>	<b>CHARGING STATION WEB INTERFACE</b> .....	<b>27</b>
	Connect to Web Interface.....	27
	Ping Charging Station from Computer in Same Network .....	27
	Change the Computer Network Settings .....	29
	Using DHCP for Connection .....	33
	Using Web Interface .....	33
	Main Dashboard.....	33
	Diagnostics .....	34
	Change the Web Interface Language.....	35
<b>5</b>	<b>REGULAR MAINTENANCE</b> .....	<b>36</b>
	Cleaning .....	36
	Access to the Maintenance Area .....	36
	General Inspection of the Station .....	37
	Check the Protection Elements.....	37
<b>6</b>	<b>TROUBLESHOOTING</b> .....	<b>39</b>
	Resetting the Charging Station.....	41
<b>7</b>	<b>CONTACT INFORMATION</b> .....	<b>42</b>

## 1

## FOREWORD

Etrel INCH charging station has been designed and tested in accordance with current and past versions of international standards. The charging station is compliant with IEC 61851 (Part 1, Part 21-2, Part 22) international standards which defines conductive AC electric vehicle charging and supports Mode 3 charging for safe recharging of standard electric vehicles.

The charging station for electric vehicles is a part of the integrated charging system that has been designed and developed by Etrel. Charging station can operate on its own, it can be connected into the cluster of charging stations, and it can be connected to the management system.



Figure 1: Etrel INCH charging station (with socket, with cable)

The management system enables safe and simple EV charging for the user and gives a comprehensive oversight and control of the charging for the operator, including the data for billing of the consumed energy and service.

The manual contains the latest information at the time of purchase. Any unauthorized modification or tampering with the product may void the product warranty. Etrel d.o.o. reserves the right to make changes to the product without further notice. Customer support department will assist with any further inquiries about the product.

**Notes to the installer:**

- Carefully read the installation instructions before installing the station. Follow all the instructions and recommendations.
- After the installation is completed, make sure to leave these instructions with the customer.

**Notes to the customer:**

- Use the charging station only in accordance with instructions for use. Carefully read these instructions and make sure to keep them for further reference. Ensure that the charging station is installed by a licensed electrician.
- Preparation of charging station installation site and installation are described in separate documents. In this document it is predisposed that charging station is installed properly and already working.

**GENERAL INFORMATION**

**INTENDED USE**

**EtreI INCH charging station is intended only for charging of electric vehicles and should not be used to charge other appliances or for any other purpose.**

- No flammable materials or liquids should be used or stored in the direct vicinity of the charging station.
- The manufacturer accepts no responsibility for damage or injuries resulting from incorrect installation or inappropriate use of the product.
- Different types of charging connectors and converters are available as a part of optional equipment to allow safe charging of any standard electric vehicle.
- Function of ventilation is not supported by charging station.
- Adaptors or conversion adaptors are not allowed to be used.
- Cord extension sets are not allowed to be used.

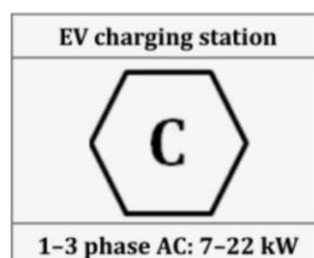

## **TEMPERATURE RANGE**

Performed temperature tests are showing that charging stations can operate at temperature of ambient of 50 °C continuously and would perform adequately at temperature spikes over that value as well.

Internal power supply is over dimensioned to compensate the loss of power at high temperatures. If the temperature of air inside the charging station would rise over 65 °C, the power supply could shut down and would re-power when temperature lowered.

The temperature dissipation of metal enclosure is excellent and no need for function of derating of charging power in case of high ambient temperature was identified.

Charging station must be protected by MCB and RCD protective devices and these devices could operate at lower current at higher temperatures, and this could cause nuisance tripping.

At ambient temperature under -25 °C the LCD display could become unresponsive, or it could also be damaged.

## **GEOGRAPHICAL RESTRICTIONS**

Charging station can be used in area of European Union without possibility of the breach of radio spectrum. For devices installed outside of European Union, this must be specified before the order and check and selection of appropriate radio components to support required bandwidths must be performed.

## **COUNTRY SPECIFIC INFORMATION**

Requirements of legislation of German Measurement and Calibration Law (Mess und Eichgesetz) are not supported in charging stations of Etrel yet. This means that they cannot be used for purposes of billing the charged energy.

United Kingdom does not recognize the CE marking of the European Union and implemented the UKCA mark. Specific of UK are also The Electric Vehicles (Smart Charge Points) Regulations 2021. Etrel can provide correct configurations of charging stations to cover all the requirements of the UK, however this must be specified with the order.

The national specifics dictated by legislation or standards and applicable to charging stations are diverse. There are different views in countries of European Union on various areas and what appropriate solutions are.

- Some countries of EU require use of sockets with shutters. This option is currently only supported in INCH DUO charging stations.
- Some countries accept alternative option to sockets with shutters, to provide additional means of disconnection - to have

a backup device in case that the first disconnection device fails. This option is only supported in charging stations with internal RCD. It could be also provided with the use of digital outputs of charging stations; however, this requires additional work and equipment for the installation.

When in doubt please consult with the seller, before buying the charging station.

## SOFTWARE

Charging station provides options of control through LCD display and additional options can be accessed connecting to the Web Interface of the charging station. This can be made with use of connectivity options wirelessly or with direct connection using the ethernet cable for connection between charging station and computer.

Information of software updates and possibility of update is available in the Web Interface. Charging station can also be connected to management system and offers possibility of remote control.

## SAFETY INFORMATION

### OPERATION



**The device must be used in accordance with the instructions contained in this manual.**

- Do not operate charging station if there is visible damage to the unit or charging cable. Call manufacturers or reseller's support department for advice how to proceed.
- Do not put fingers into the charging connector.
- Do not operate the charging station with wet hands.
- The charging station manufacturer cannot be made liable for damage or injury caused by improper handling, installation, or use of the product.
- Any usage of the product not covered in this document is not allowed and could cause injury or even death.
- When the charging station without integral RCD device is installed, the proper RCD device should be installed in the main electrical cabinet.
- When the charging station without integral overcurrent device is installed, the proper overcurrent device should be installed in the main electrical cabinet.

## **IRREGULARITY OR INTERFERENCE AT OPERATION**

In the event of irregularities or interference in the operation of the device, immediately stop using the charging station and inform the charging station operator of the situation by phone number located on the housing or other place.

## **MAINTENANCE**

- Charging station can be maintained and repaired by qualified personnel only.
- Charging station's power supply should always be switched off during the maintenance and repair.
- Avoid hazardous risks. Only the manufacturer, an authorized service technician, or technically qualified personnel may replace damaged charging station or its components.

## **FIRE SAFETY MEASURES**

At the location of car charging, the fire hazards and thus the threats are increased during the process of charging. The overall design of our products is made on the basis assumption that the fault could occur on any element of the system. Either in the electrical wiring of power supply, in wiring or inside of the charging station, or in the car.

The enclosure and the assembly design of the charging station are made in such a way that the contact of the user to hazardous parts is not possible. In the event of fire, metal enclosure would constrain a fire and would not allow the propagation outside of the enclosure. Regarding the fire safety in all possible cases of installation, that are out of control of our company, several recommendations are listed:

- **The charger must be installed outside the hazardous area.**
- The installation of the charging station can be performed only by professional electrician and must comply with the installation manual and local installation rules.
- Ensure that there is enough space to manoeuvre vehicles into their designated charging areas and that in event of fire the escape and rescue routes are not obstructed.
- No flammable or combustible material should be stored within the charging area.
- Provision of suitable portable fire extinguisher at the location of the charging station is proposed.

## **FIREFIGHTING MEASURES**

### **CHARGING STATION FIRE**

In the event of a charging fire, the usual rules in the event of an electrical cabinet fire apply. In case of fire please follow these steps:

- In the event of a fire, immediately stop using the charging station and call the appropriate services (fire brigade).
- If possible, disconnect the station from the power supply by pressing the fire protection switch (if present) or another switch responsible for cutting off the power supply to the station.
- Retreat from fire area.
- Extinguishing should be carried out with extinguishers intended for extinguishing electrical devices up to 1000 V.

### **Do not extinguish live electrical installations and devices with water!**

The following is general information obtained from various sources. For detailed instructions on extinguishing fires of electric vehicles or their batteries, fire brigade have appropriate procedures already established.

### **VEHICLE FIRE**

Vehicles, made of light metal, such as magnesium or aluminium, develop high temperatures above 1000 °C when burning. When extinguished with water such a high temperature evaporates it and can cause burning particles of distinctly white colour and high temperatures to fly around the vehicle. Extinguishing such vehicles requires great care in forming the water jet and in the amount of water.

If a burning vehicle is connected to a charging station, it is necessary to ensure that the charging station is in a voltage-free state by disconnecting the line from which it is supplied.

If firefighters are at the scene of a fire in less than half an hour, the battery usually does not ignite yet and the vehicle can be extinguished easier, and all extinguishing agents can be used. The general recommendations are mainly to use water and foam.

### **BATTERY FIRE**

In general, battery manufacturers, regardless of the type of battery, recommend water for successful extinguishing, although reactions may occur.

If the batteries catch fire, they will burn until they burn out completely. Another option is to immerse the batteries in water for at least half an hour. If the battery is not extinguished successfully, the fire will recur.



## ENVIRONMENTAL SAFETY MEASURES

When implementing protection measures, environmental protection must also be observed. For this reason, special care has been put into selection of the components and their compliance with the Directive on the restriction of the use of certain hazardous substances in electrical and electronic equipment (RoHS). This directive restricts use of hazardous materials in the manufacture of various types of electronic and electrical equipment.

The substances banned under RoHS are heavy metals, lead (Pb), mercury (Hg), cadmium (Cd), hexavalent chromium (CrVI), polybrominated biphenyls (PBB), polybrominated diphenyl ethers (PBDE), and four different phthalates (DEHP, BBP, DBP, DIBP).

The restricted materials are hazardous to the environment and pollute landfills and are dangerous in terms of occupational exposure during manufacturing and recycling.

Another example of use of environmentally friendly materials in our products is compliance to REACH, which is a regulation of the European Union, adopted to improve the protection of human health and the environment from the risks that can be posed by chemicals. REACH regulation also promotes alternative methods for the hazard assessment of substances to reduce the number of tests on animals. Packaging of our products is environmentally friendly and materials degradable.

## CORRECT DISPOSAL OF THIS PRODUCT AND SUSTAINABILITY

### INFORMATION ABOUT WEEE DIRECTIVE



Of major importance is the compliancy with the Waste Electrical and Electronic Equipment Directive (WEEE) as well. The scope of this Directive is the reuse, recycling, and disposal of electrical equipment during complete lifecycle and after their end of life.

The product and its electronic accessories should not be disposed of with other household waste at the end of their working life. To prevent possible harm to the environment or human health from uncontrolled waste disposal, please separate these items from other types of waste and recycle them responsibly to promote the sustainable reuse of material resources.

Household users should contact either the retailer where they purchased this product, or their local government office, for details of where and how they can take these items for environmentally safe recycling.

Business users should contact their supplier and check the terms and conditions of the purchase contract. This product and its electronic

accessories should not be mixed with other commercial wastes for disposal.

## **COMPLIANCY**

### **SIMPLIFIED EU DECLARATION OF CONFORMITY**

Hereby, Etrek d.o.o. declares that the radio equipment type INCH is in compliance with Radio Equipment Directive 2014/53/EU. The full text of the EU Declaration of Conformity is available at the following internet address:

<https://etrel.com/charging-solutions/inch-home/> or

<https://etrel.com/charging-solutions/inch-pro/>

Select "Access documentation" and then "Certificates".

### **TESTED COMPLIANCY WITH STANDARDS**

Etrek INCH charging station was tested at accredited third-party laboratory SIQ - Slovenian Institute of Quality and Metrology. Performed tests cover all the requirements of RED, LVD and EMC directives of the European Union, according to the specifications of the following standards:

- IEC 61851-1:2017 (EN IEC 61851-1:2019)
- IEC 61851-21-2:2018
- ETSI EN 301 489-1 V2.2.3
- ETSI EN 301 489-17 V2.2.1
- ETSI EN 301 489-52 V1.1.0
- ETSI EN 301 489-3 V2.1.1
- EN 60529:1991 + A1:2000 + A2:2013
- EN 62262:2002

## SAFETY RISK ANALYSIS

DANGER OR RISK	RELEVANT	PROTECTIVE MEASURES	IN ACCORDANCE WITH
Preliminary observations	YES	Application of Annex A of CENELEC Guide 32, Safety aspects relating to low voltage equipment.	CENELEC Guide 32
Safety integration	YES	Application of Annex A of CENELEC Guide 32, Safety aspects relating to low voltage equipment, in particular the "3-step-method": 1) Inherent design measures, 2) Technical safety measures, 3) Information for use.	CENELEC Guide 32
General	YES	Charging station complies to all requirements of the standards of the EN 61851 family, to all parts relevant to AC conductive charging and is compliant to all versions, current and old. This family of standards covers requirements for charging stations from all aspects, however some details are covered in other standards, as listed in this table.	EN 61851-1:2001, EN 61851-1:2011, EN 61851-1:2019, EN 61851-21:2002, EN 61851-22:2002
<b>Protection against electrical hazards</b>			
Leakage current	YES	To prevent leakage currents, the suitable RCD protection device is used either in charging station, or in an installation. Each socket must be protected by individual RCD. The power supply was selected to have a negligible leakage current.	Directive LVD 2006/95/ED (through April 19, 2016) and Directive 2015/30/EU (from April 20, 2016),
Energy supply	YES	Overload and short-circuit protection is ensured with use of suitable MCB. Additional surge protective device could be required by national legislation. Protective devices can be installed either in charger, or in an installation upstream. Coordination and selectivity of protection devices with upstream devices should be ensured, so that only the protection device, the closest to the fault, operates.	EN 60947-1:2007, EN 60947-2:2006, EN 60947-3:2009, EN 60947-4-1:2010, EN 61008-1:2004, EN 61008-1:2012, EN 61009-1:2004, EN 61009-1:2012, EN 60309-1:1999, EN 60309-2:1999, EN 60947-1:2007, EN 60947-2:2006, EN 60947-2:2017, EN 60947-3:2009, EN 60947-4-1:2010, EN 62196-1:2012, EN 62196-1:2014, EN 62196-2:2012, EN 62196-3:2014, EN 50065-1:2011, EN 50065-4-2:2001, EN 60950-1:2006, EN 50065-4-7:2005, IEC TS 61439-7:2018,
Stored charges	YES	The components are dimensioned in such a way that they cannot cause a charge that would be hazardous to human health. In case of vehicle malfunction, the possible hazard of stored charge is mitigated by the use of RCD.	EN 60309-1:1999, EN 60309-2:1999, EN 60947-1:2007, EN 60947-2:2006, EN 60947-2:2017, EN 60947-3:2009, EN 60947-4-1:2010, EN 62196-1:2012, EN 62196-1:2014, EN 62196-2:2012, EN 62196-3:2014, EN 50065-1:2011, EN 50065-4-2:2001, EN 60950-1:2006, EN 50065-4-7:2005, IEC TS 61439-7:2018,
Arcs	YES	The use of suitable switching and protective devices ensures that possible arcs are extinguished quickly and without causing damage.	IEC Guide 116:2018, ISO/IEC Guide 51:2014
Electric shock	YES	Basic protection is provided with selection of appropriate insulation of all components and in addition live parts are not accessible during charging. Fault protection is achieved with earthing of all exposed conductive parts and with automatic disconnection of the supply in case of a fault. Additional protection is also provided, with use of high sensitivity RCD's.	IEC Guide 116:2018, ISO/IEC Guide 51:2014
Burns	YES	Electrical burns and other injuries are prevented with use of appropriate protective devices, properly designed insulation and prevention of arcs.	IEC Guide 116:2018, ISO/IEC Guide 51:2014
<b>Protection against mechanical hazards</b>			
Instability	YES	The use of quality housing with use of additional structural supports ensures high resistance on mechanical stress. The proper installation of mounting anchor ensures that the charger is rigidly supported and can not turn over. Our charging stations are tested to determine the IK code (degree of protection provided by enclosure) in combination with tests to determine IP code (ingress protection).	EN 62262:2002, EN 60529:1991
Break-down during operation	YES	Charger construction ensures that break-down during operation is not possible in normal conditions. This would be possible only with high enough external force, e.g. vehicle collision. For this reason the recommendation for public charging stations is to use protective bollards.	
Ingress	YES	The use of quality housing with use of sealing foam and filters ensures high resistance to ingress of particles. Our charging stations are tested to determine the IP code (ingress protection) in combination with tests to determine IK code (degree of protection provided by enclosure).	
Falling or ejected objects	NO	/	/
Sharp edges or corners and inadequate surfaces	YES	There is a possibility that sharp edges occur during the production process during the cutting and assembly of the housing. For this reason, possible sharp edges that could harm a person, were identified and are grinded away after the assembly. The wires are also protected so that they do not come into contact with the remaining sharp edges. Proper processing, finishing and coloring procedures of the surfaces ensure high quality product.	Directive LVD 2006/95/ED (through April 19, 2016) and Directive 2015/30/EU (from April 20, 2016)
Moving parts, especially where there may be variations in the rotational speed of parts	YES	The only moving part representing the hazard is the opening and closing of the doors. The doors should be closed only if there is nothing blocking them (either mechanical object, or human hand). This risk is also mitigated with the explanation in the user and installation manual.	IEC 60335
Vibration	YES	The major concern with vibrations is the loosening of electrical connections. For this reason, special care is made during the production process to use the optimum torque and tightening sequence for fasteners with use of tools with settable screwing torque.	IEC 60335
Improper fitting of parts	YES	The tolerances of parts are high enough to not represent a problem during the manufacturing process. In addition, the manufacturing instructions are covering all possible improper fittings of connectors and other components. All charging stations are put on the testing line after assembly where possible improper fitting would be identified.	IEC 60335

## EtreI INCH | User Manual

DANGER OR RISK	RELEVANT	PROTECTIVE MEASURES	IN ACCORDANCE WITH
<b>Protection against other hazards</b>			
Explosion	NO	/	/
Hazards arising from electric, magnetic, and electromagnetic fields, other ionizing and nonionizing radiation	YES	Our charging stations are subjected to tests and certification to ensure safe operation from the view of electromagnetic compatibility (EMC) and electromagnetic interference (EMI). The compliance with EMC limits ensures that the charging station is not emitting electromagnetic fields that could affect other devices and compliance with EMI limits ensures immunity of the charging station and safe operation when subjected to electromagnetic fields that could occur in the vicinity of the charging station. In addition the charging station are tested and certified in accordance with radio equipment directive (RED) when applicable. The certification proves that the electromagnetic fields generated by the charger are limited to the extend necessary for the operation.	EMC Directive 2004/108/EC (through April 19, 2016) and EMC Directive 2014/30/EU (from April 20, 2016), EN 61000-6-1:2007, EN 61000-6-2:2005, EN 61000-6-3:2007, EN 61000-6-4:2007
Electric, magnetic or electromagnetic disturbances	YES		
Optical radiation	NO	/	/
Fire	YES	In the event of fire, metal enclosure would constrain a fire and would not allow the propagation outside of the enclosure. Used materials are resistant to ignition and spread of fire. External parts of insulating material and insulating parts are resistant to abnormal heat and to fire. Installed RCD device protects against fire aswell.	EN 61439-1:2011, HD 60364-4-42:2011
Temperature	YES	Using the equipment beyond its environmental specifications may give rise to temperature hazard. This is well mitigated with selection of appropriate materials.	EN 61439-1:2011, IEC TS 61439-7:2018, HD 60364-4-42:2011, EN 60068-1:2014
Humidity	YES	High humidity inside of charging station can damage the electrical components. To avoid the risk, during the installation, the base of charging station should be covered with polyurethane foam or similar filling. The charging station has vents to enable natural ventilation. The finishing of the external surfaces offers high protection against environmental conditions and prevents the corrosion and rust. Additional measures can be the addition of silica gel or similar hygroscopic material. Also, the option to install a small heater preventing condensation inside of charger is provided.	EN 60068-1:2014
Acoustic noise	NO	No significant noise levels are being produced. Noise that the electronic components emit is negligible in comparison with noise of vehicle's internal charger.	EN 60068-1:2014
Biological and chemical effects	YES	Special care has been put into selection of the components and their compliance with the Directive on the restriction of the use of certain hazardous substances in electrical and electronic equipment (RoHS). Another example of use of environmentally friendly materials in our products is compliance to REACH, which is a regulation of the European Union, adopted to improve the protection of human health and the environment from the risks that can be posed by chemicals.	REACH, RoHS
Emissions, production and/or use of hazardous substances (e.g. gases, liquids, dusts, mists, vapour)	YES		
Unattended operation	YES	After the starting of charging process no additional inputs are needed as charging stations are designed to be able to charge without supervision. The implemented protection measures would operate independently of human presence.	EN 61851
Connection to and interruption from power supply	YES	The charging station does not connect EV to the electrical grid under full load. Firstly, the connection to the electric vehicle is made only after security checks and mitigation between charger and vehicle. The charging current is then gradually increased to full allowed current. Thusly, the connection of the load does not represent a "spike" in consumed power. In case of interruption the charging station shuts down gracefully to not damage any components. The proper earthing also promotes the quick discharge of possible built-up charge.	EN 61851
Combination of equipment	NO	/	/
Implosion	NO	/	/
Hygiene conditions	NO	/	/
Ergonomics	YES	The user interface is carefully designed, to offer the user complete and concise information in a clear manner. The ergonomic principles relevant to safe movement and handling are covered .	IEC 60335
<b>Functional safety and reliability</b>			
Equipment design	YES	Charging station design was made in accordance with all major international standards that are considered in scope of e-mobility and is designed and constructed to be safe and reliable to prevent hazards arising and withstand normal use in foreseeable environmental conditions, misuse and errors in logic.	Directive 2006/95/EC, EN 61508-1:2010
Type related hazards	YES	Protection against unexpected start and stop was executed with emphasis on hazards resulting from failure to stop.	EN 61851
System faults	YES	In case of foreseeable system faults, or during and after interruptions or fluctuation of the power supply the monitoring, protection and disconnection means ensure safe operation.	EN 61851
<b>Safety-related security</b>			
Protection against casual or coincidental violation	YES	The control system provides the capability for human user identification and authentication.	EN 61851
Protection against intentional violation using simple means with low resources, generic skills and low motivation	YES	The control system provides the capability for unique human user identification and authentication.	EN 61851
Protection against intentional violation using sophisticated means with moderate resources, specific skills related to the considered equipment and moderate motivation	YES	The control system provides the capability to employ multifactor authentication for human user access to the control system.	EN 61851
Protection against intentional violation using sophisticated means with extended resources, specific skills related to the considered equipment and high motivation	NO	The control system provides the capability to employ multifactor authentication for all human user access to the control system.	/
<b>Information requirements</b>			
Information requirements	YES	Information requirements are defined in several documents and standards. These documents and requirements were identified and taken into account for the preparation of user manuals and other documents.	GPSD, LVD, EMC, EN 60335-1, EN 60335-2-15, EN 62079, RoHS, REACH

\* Although standards listed in the table are referenced only as CENELEC versions (EN - European Standard, or HD - Harmonization Document), compliancy applies to their international counterpart versions as well (IEC prefix). However, the designation of the year of the standard can be different for IEC versions.

All our charging stations are tested and proved compliant with EN 61851 Part 1, Part 21-2, and requirements of harmonized standards to fulfil RED, LVD and EMC directive. These tests and judgement of compliancy was performed by external accredited organization, SIQ - Slovenian Institute of Quality and Metrology, Mašera - Spasičeva ulica 10, 1000 Ljubljana, Slovenia, [www.siq.si](http://www.siq.si).

## **DESIGN CONSIDERATIONS**

Special care has been put into selection of components and materials and their compliance to requirements set in standards, technical directives, and rules of good practice.

The internal wiring was carefully designed, and the propriety of whole assembly thoroughly evaluated. Basic design considerations include voltage, insulating materials, time under voltage stress and degree of pollution at the location.

Creepage distances, clearance between circuits and spacing to metal enclosures are important requirements for insulation coordination. Thus, calculation and measurement of clearance and creepage distances, in accordance with requirements, are one of the significant parts in design of our products. They are dimensioned to withstand the required impulse withstand voltage and to withstand the long-term continuous operation.

A charging station operates with an RCD device, which is designed to protect against the risks of electrocution and in addition offers protection against fire caused by earth faults. It is a sensitive safety device that switches off electricity automatically if there is a fault.

The ingress protection class of IP56 proves, that the enclosure of the charging station is protecting the internals against ingress of solid objects, permits only limited ingress of dust and is protected against water splashes from all directions. Impact protection, of at least IK10 states, that the charging station can withstand impacts, equivalent to 5 kg dropped from height of 40 cm. As required, tests for the IK class were performed before testing of IP class.

## **LICENSES**

At the same location as the complete EU Declaration of Conformity, in the folder "Licenses", manifest file with information about versions and licenses of integrated software can be found.

<https://etrel.com/charging-solutions/inch-home/> or

<https://etrel.com/charging-solutions/inch-pro/>

**Select "Access documentation" and then "Licenses".**

## TRANSPORTATION AND STORAGE INSTRUCTIONS

### TRANSPORTATION

Please make sure that the charging station (or pallet of charging stations) is stable during the transport.

Transportation temperature range: -30 °C to +70 °C

### STORAGE

The charging station is delivered in a cardboard box. We recommend that the charging station is kept in this packaging until the installation. Packaging must be removed before installation of the charging station.

Storage temperature range: -30 °C to +70 °C

### STACKING

#### INCH Home/Pro with cable:

- 5 boxes maximum stacking, symbol:  
(Maximum of 4 boxes on top of the bottom box)



#### INCH Home/Pro with socket:

- 7 boxes maximum stacking, symbol:  
(Maximum of 6 boxes on top of the bottom box)



### PACKAGING

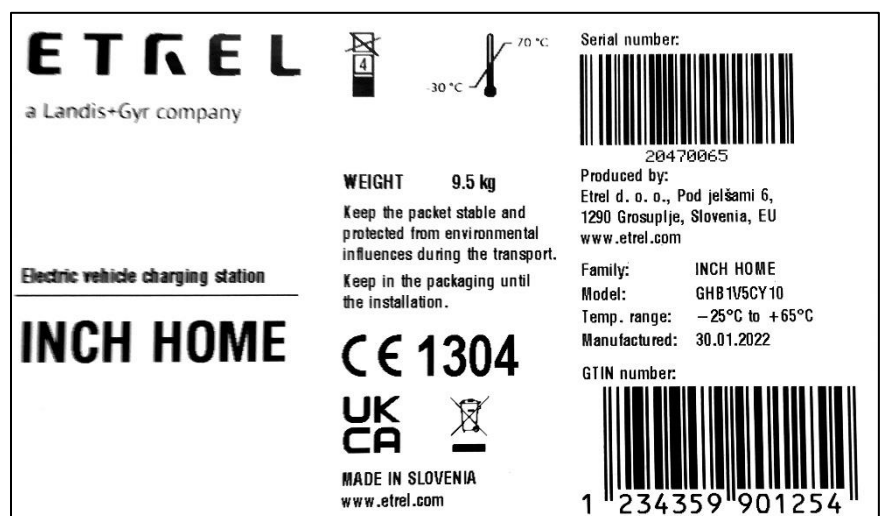

Figure 2: Label on the packaging

## 2

# PRODUCT DESCRIPTION

## BASIC FUNCTIONALITIES

Etrel INCH is a smart charging station that can predict EV charging habits and help charge the car by the time it is needed, at the lowest possible cost.

Charging station comes with the LCD screen that guides through the charging process and provides charging information. Charging station comes with several connectivity options (including Wi-Fi, LTE, and Ethernet) and open protocol support and can be seamlessly integrated in smart home.

To connect Etrel INCH charging station, it either comes with the socket or cable. Depending on the type of charging station.



1. LCD screen
2. Status light
3. Settings button
4. Confirmation button
5. Socket
6. Maintenance doors
7. Charging cable



Figure 3: Etrel INCH with socket

Figure 4: Etrel INCH with cable

## BASE SPECIFICATIONS



- **Input:** 230/400V~; 3W+N+PE; 50/60 Hz; 32 A<sub>max</sub>
- **Output:** 230/400V~; 3W+N+PE; 50/60 Hz; 32 A<sub>max</sub>
- **Maximum charging power:** 7,36 kW (1-phase), 22,08 kW (3-phase)
- **Maximal power consumption of the device:**  
 From 7 W to 11 W (highest measured value of full configuration: 10,33 W)  
 Configuration of individual device has an impact on the power use of the charging station. The values of the stand-by power are based on the measurements that were performed on different configurations of products.

Specification of frequency bands and transmitting power (it is possible that not all modules are part of an actual device).

<p><b>LTE module</b></p> <p><u>Frequency bands:</u></p> <p>LTE-FDD: B1 (2100 MHz), B3 (1800 MHz), B5 (850 MHz), B7 (2600 MHz), B8 (900 MHz), B20 (800 MHz)</p> <p>LTE-TDD: B38 (2600 MHz), B40 (2300 MHz), B41 (2500 MHz)</p> <p>WCDMA: B1 (2100 MHz), B5 (850 MHz), B8 (900 MHz)</p> <p>GSM/EDGE: B3 (1800 MHz), B8 (900 MHz)</p> <p><u>Transmitting power:</u></p> <p>33dBm±2dB for GSM</p> <p>24dBm+1/-3dB for WCDMA</p> <p>23dBm±2dB for LTE-FDD</p> <p>23dBm±2dB for LTE-TDD</p>	<p><b>LTE Router</b></p> <p><u>Frequency bands:</u></p> <p>4G (LTE-FDD): B1 (2100 MHz), B3 (1800 MHz), B5 (850 MHz), B7 (2600 MHz), B8 (900 MHz), B20 (800 MHz)</p> <p>4G (LTE-TDD): B38 (2600 MHz), B40 (2300 MHz), B41 (2500 MHz)</p> <p>3G: B1 (2100 MHz), B5 (850 MHz), B8 (900 MHz)</p> <p>2G: B3 (1800 MHz), B8 (900 MHz)</p> <p><u>Transmitting power:</u></p> <p>21.9 dB</p>
<p><b>Wi-Fi module</b></p> <p><u>Frequency band:</u></p> <p>2.4 - 2.4835 GHz</p> <p><u>Transmitting power:</u></p> <p>up to 15 dBm</p>	<p><b>RFID module</b></p> <p><u>Frequency band:</u></p> <p>13.56 MHz (HF)</p> <p><u>Transmitting power:</u></p> <p>up to 8 dBm</p>



### DIMENSIONS

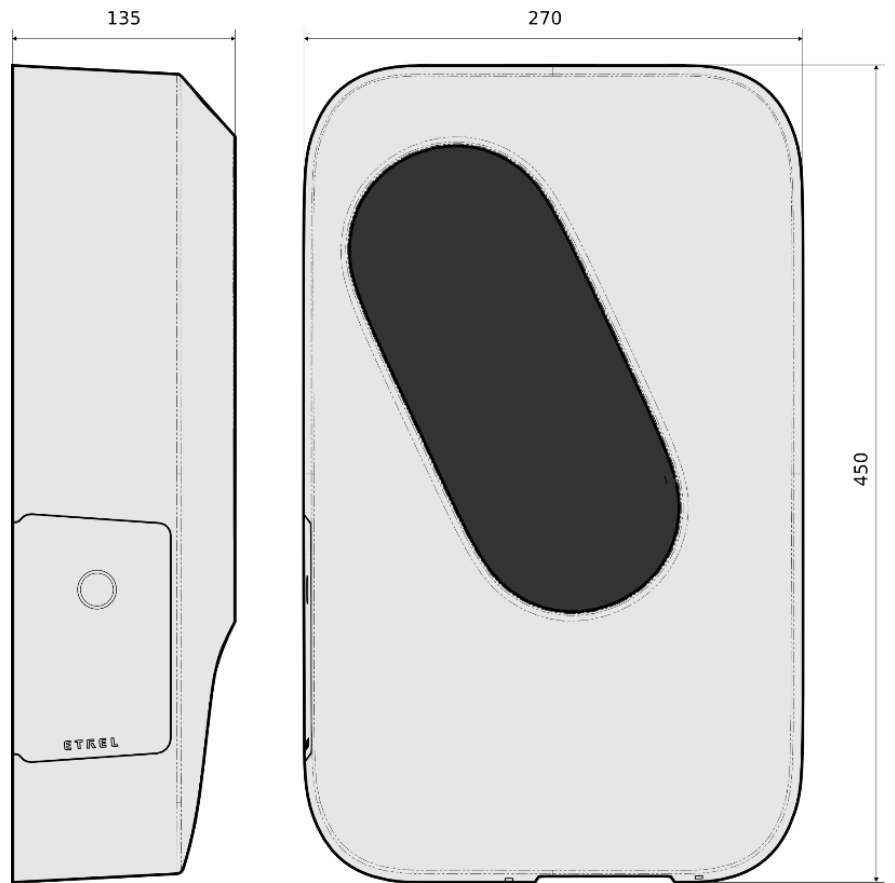

Figure 5: Dimensions of INCH charging station

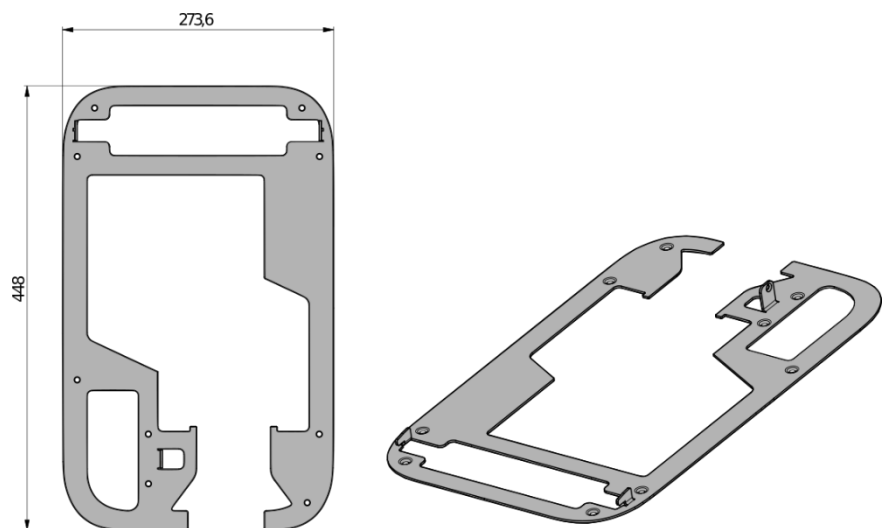

Figure 6: Dimensions of the wall mounting bracket

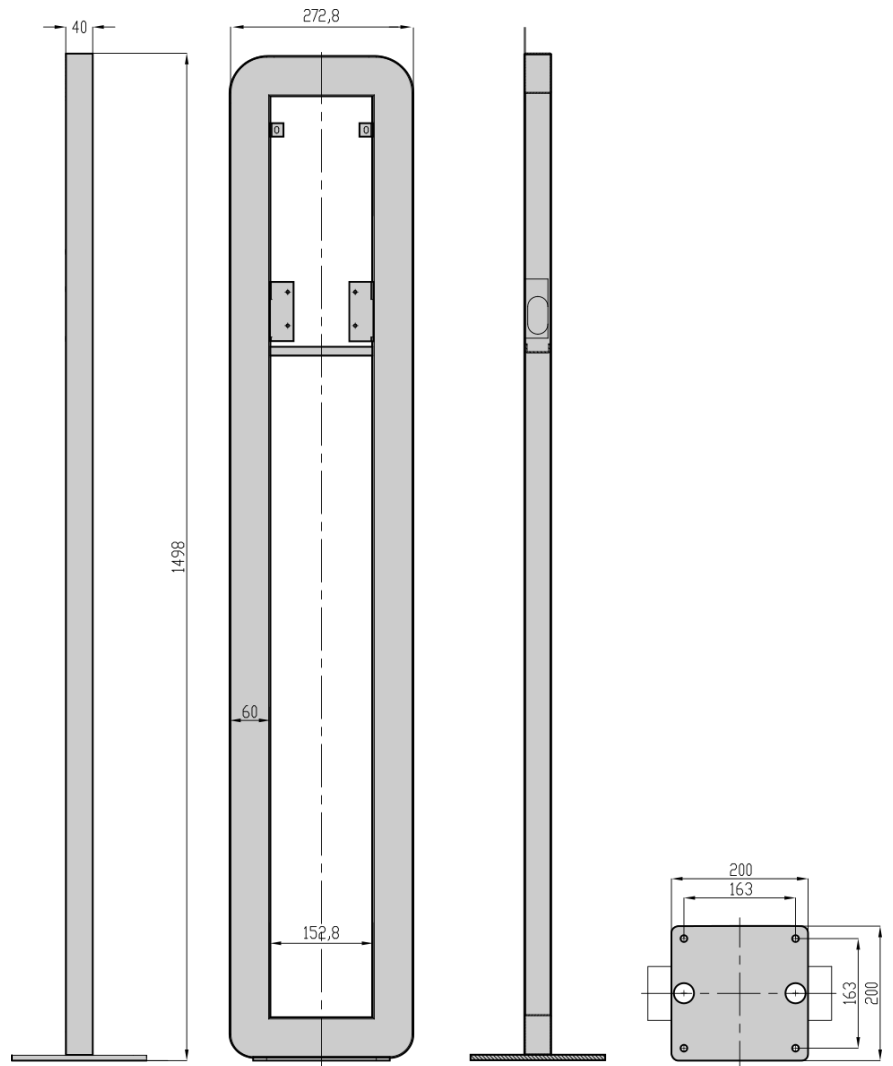

Figure 7: INCH mounting pole

## **CONTENT, OPTIONAL AND EXTRA EQUIPMENT**

- Charging station (with Type 2 cable or Type 2 socket),
- Wall mounting bracket,
- 9 × wall plugs for securing the mounting bracket using screws to the wall,
- 9 × screws to mount the bracket to the wall,
  - Screws dimensions: 4.5 x 40 and 4.5 x 60 [mm],
- Cable gland rubber seal for smaller cable dimensions
- \*9 × wall spacers
- \*2 × keys to open charging station service doors,
- \*Hex key to open charging station maintenance doors,
  - Hex key dimensions: 2.5
- \*PLC LAN module,
- \*Magnetic cable holder (different version for longer cables > 3 m),
- \*INCH mounting pole,
- \*Underground anchoring structure,
- \*Etrel Load Guard device.

\* *Optional, depending on the purchased model.*

*\*\* For configurations with socket, there is a leftover of two screws M4x80 that are not used for the installation.*

### **ETREL LOAD GUARD**

Etrel Load guard is a separate device that is installed in the building's electric cabinet. It measures the electric current in the building's installation and sends real-time measurements to the charging station.

Load Guard allows charging with maximum current without overloading the fuses. The main use is in cases where there are other consumers or production of energy at the location (e.g., photovoltaics). It operates with individual charging station or with cluster of charging stations.

Power management of master charging station decides, based on information provided by Load Guard, what target current to set on its connector and other stations of the cluster. If necessary, it will increase or decrease the charging power or even stop it completely to prevent the fuses from switching off due to overcharging.

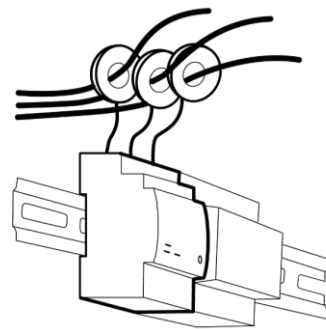
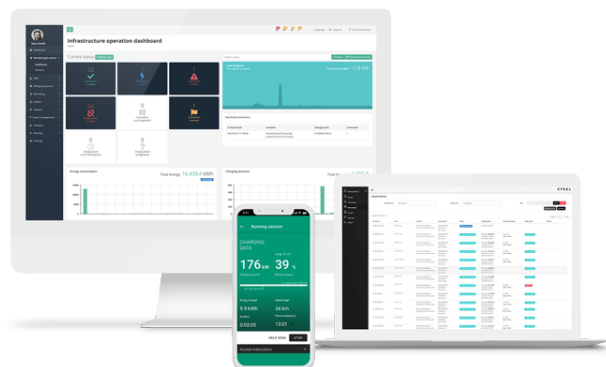

**Figure 8: Load Guard**

### **ETREL OCEAN**

Etrel Ocean is a complete software solution for scalable electric vehicle charging management that supports complete overview and control of charging stations while covering numerous use cases.

Usually, it is not needed for home use, its advantages are in the field of management of (real and virtual) clusters of charging stations. It is adaptable and configurable to different business cases.



**Figure 9: Etrel Ocean**

## IDENTIFY PRODUCT VARIANT

Etrel INCH has multiple variants that differ based on connector type and connectivity option. To identify charging station, there are two possibilities. Either checking the manufacturer sticker or on the web interface in Diagnostics menu.

Model number is located on all stickers. Identification of charging station is sometimes needed by the support, so they can identify potential issue.

User will get all the needed information on the sticker located on the inside of maintenance doors. Information about charging station model, serial number, software version and version of cc hardware, cc driver and cc firmware can also be obtained, on the web interface of Etrel INCH charging station.

Charging station or its packaging has 3 stickers, presented on the following figure. Sticker with basic information is located on the delivery package **a)**, one at the back of service doors has all the technical information **b)** and last one is located inside the side maintenance doors, containing information about connectivity **c)**.

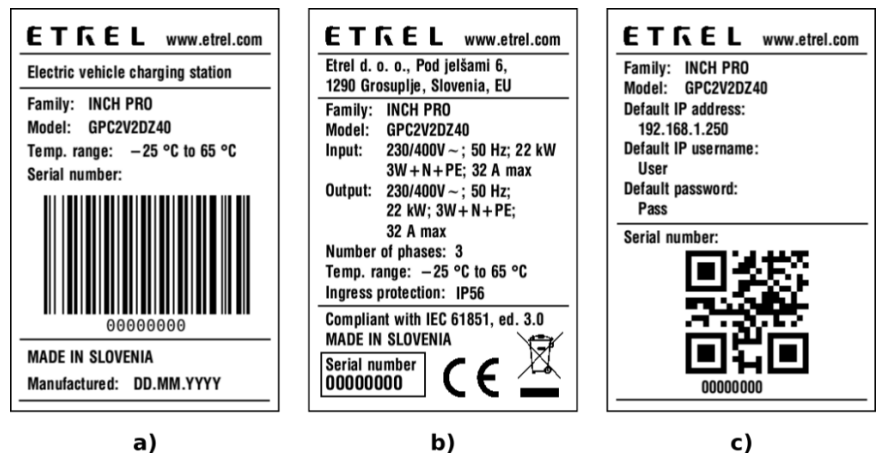
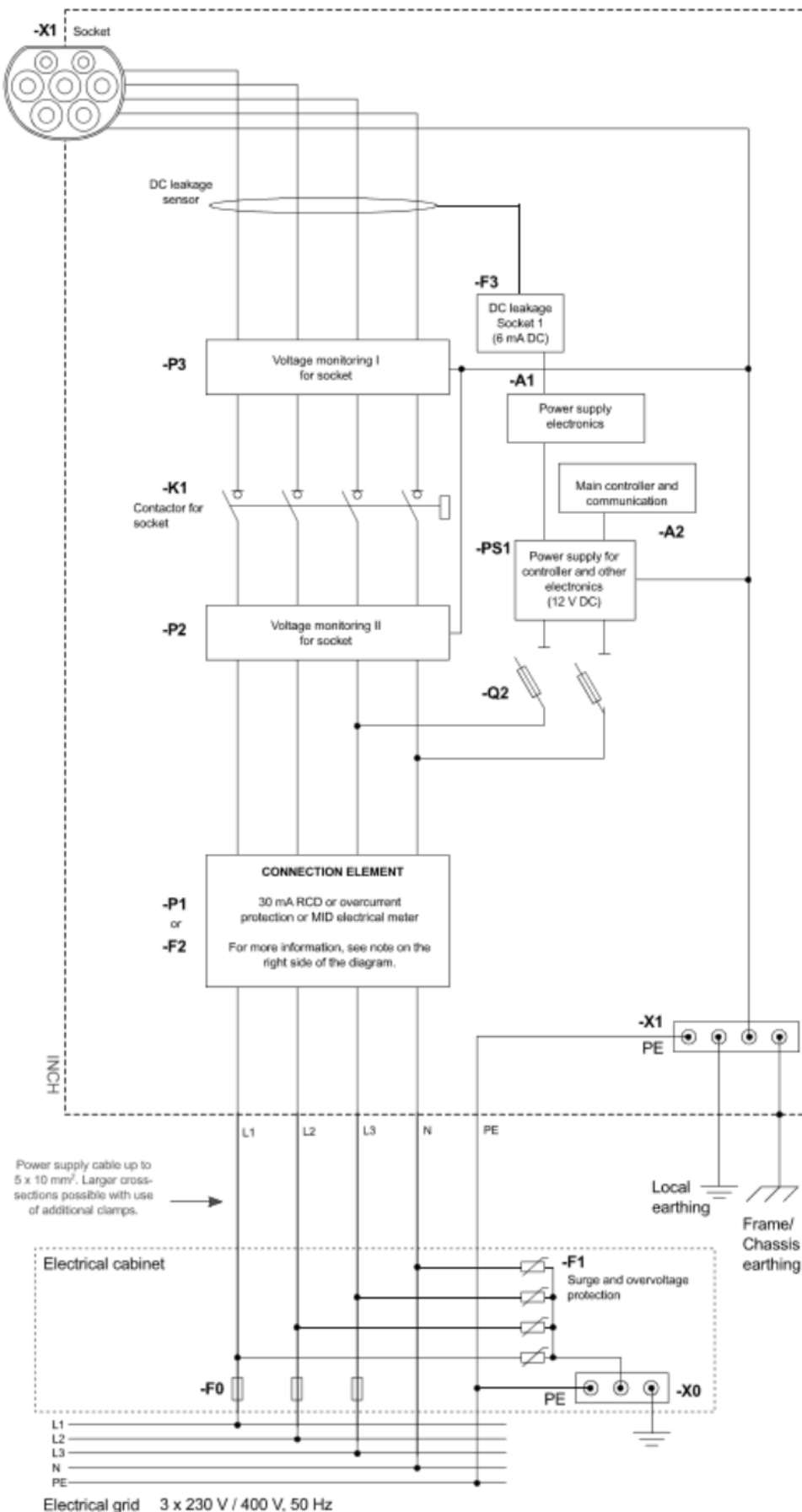

Figure 10: Three different stickers, sticker on the delivery package, on the maintenance doors and inside the maintenance space, behind maintenance doors

## CIRCUIT DIAGRAM



### NOTE:

#### CONNECTION ELEMENT

Connection element is used to connect supply cables to the charging station. It can be either of the three components specified below (A, B or C), depending on the version of the product.

#### (A) Overcurrent protection

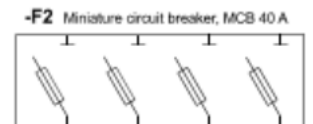

#### (B) Measurement of the consumed energy

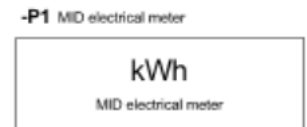

#### (C) Residual current device

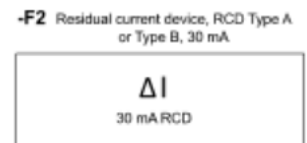

Actual wiring of a product can be different across different versions of the product.

# 3

## OPERATION AND CHARGING PROCEDURE

INCH charging station can be controlled locally or remotely, through web interface, or through charging station management system. Configuration and usage of the charging station’s web interface is described in the next chapter.

### FIRST POWER UP



**Before starting the station, it is absolutely necessary to read this manual and the technical specification of the device.**

- Connect charging station to the power supply in the electrical cabinet. Installation feeder should be turned on.
- When the charging station has either overcurrent or RCD protection installed, check whether the protection element is in ON position.
- Charging station is powered up automatically when it is connected to the electricity.
- When the charging station is power up for the first time it can take several minutes for station to get ready to start using it to charge EV.

### STATUS OF LED

LED colour	State	LED action	Sub-state
Green	- Booting - OK - Available	Steady green	Booting
		Steady green	Connector available
		Blink green slow	Preparing for charging
		Blink green fast	Waiting for vehicle
Blue	- Charging	Blink blue	Charging
		Steady blue	Charging ended
		Steady blue	Charging paused (by EV or by EVSE)
Red	- Fault - Unavailable	Blink red	Fault
		Steady red	Connector unavailable

## **SETTING OF MAXIMAL CHARGING CURRENT**

Max power is set by the installer based on the grid capabilities where charging station is installed. If there is need to change it, please set the current limitation in the charging station's web interface before starting the first charging session.

## **FIRST CHARGING SESSION**

When the charging station is ready to be used, follow the procedures described on the LCD screen. Two charging modes can be selected:

- Fast charging (default)
- Interactive charging

Charging modes are chosen during the charging session.

During the fast-charging EV will be charged with the max available charging power as fast as possible. Max power is set by the installer based on the grid capabilities where charging station is installed.

When Interactive charging is chosen the charging schedule will be modified based on the inserted departure time. If it is not inserted, it will be based on the default value. Historic data are recorded from the first charging session onward and can only be used after the first charging session is finished.

More charging session means more accurate session prognosis and schedules. Charging schedule will be created based on electricity prices, other loads, and PV production to make sure EV is charged in appropriate time while taking in consideration other constraints.

## **CHARGING PROCEDURE**

### **STEP 1: WAKE**

In normal conditions, the charging station's LCD screen will likely be in the screen saver mode. Charging station can be woken up by simply tapping the screen.

Screen saver mode can be chosen in the charging station's web interface. Three options of display setting exist: turned on all the time, blinking or turned off until touched.



Figure 11: Screen saver

## STEP 2: AUTHORISATION

Depending on the charging station chosen authorisation mode, different screens will be shown that will need different actions from user to continue with the charging session. What authorisation is allowed can be setup in the charging station's web interface Configuration menu.

### Plug and charge mode

In the plug and charge mode message is shown to insert the cable and start the charging session.

### Needed authorisation

If authorisation is needed, select the type that will be used to authorise and continue with the charging session.

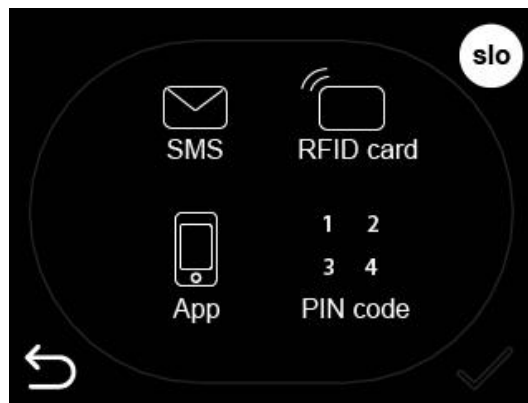

Figure 12: Choose authorisation method

- a. Insert PIN code



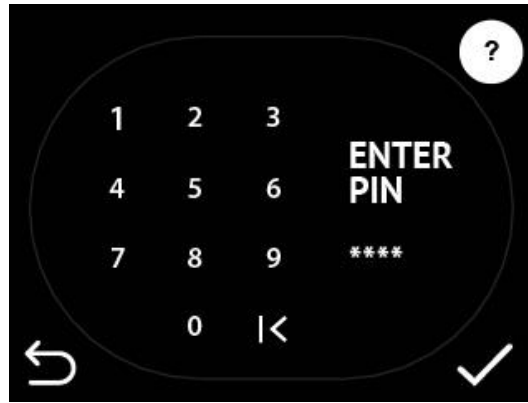

Figure 13: Insert PIN code

b. Use mobile app to authorise

Either type the code of the station to the mobile app or scan QR code with mobile.

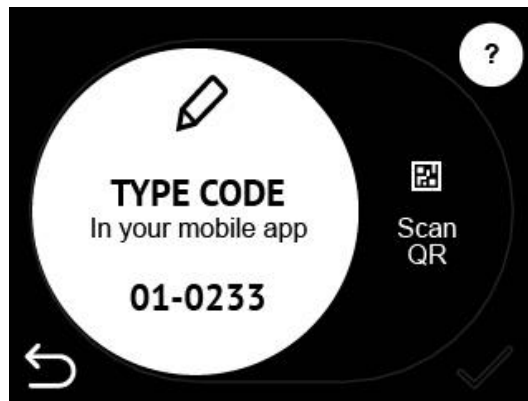

Figure 14: Insert charging station's EVSE code



Figure 15: Scan QR code

c. Swipe RFID card

By simply swiping the RFID card below the LCD touch screen where the RFID module is installed, the authorisation on the charging station is made and the charging session can begin.

### STEP 3: CONNECTING THE CABLE

After the successful authorization, the screen with the description to connect the cable is shown.

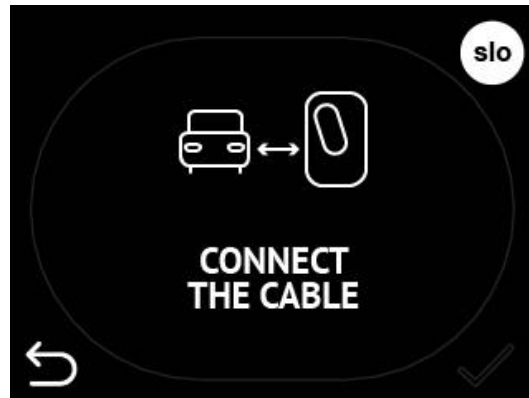

Figure 16: Connect the cable to charging station and EV

If the cable is connected before the authorization this screen will be left out and after the authorization next screen “Waiting for vehicle to respond” will be shown. When the cable is connected charging station will start charging as soon as EV responds.



Figure 17: Charging station is waiting for EV to responds and starts charging

### STEP 4: DEPARTURE TIME INPUT

As soon as the charging session begins, the screen to input departure time is shown. Presented departure time is the one calculated by the charging station based on previous charging habits. The presented departure time can be changed to make sure that the EV is charged.

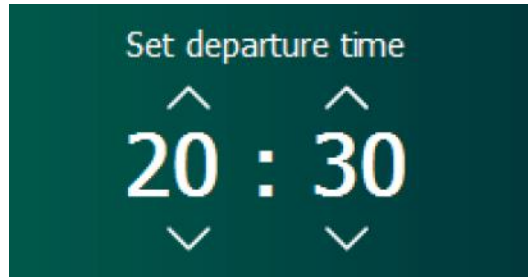

Figure 18: Set the departure time

When the departure time is set, or default setting is let through charging data will be shown. What charging information is shown depends on the settings of web interface.



Figure 19: Example of shown energy on the LCD screen

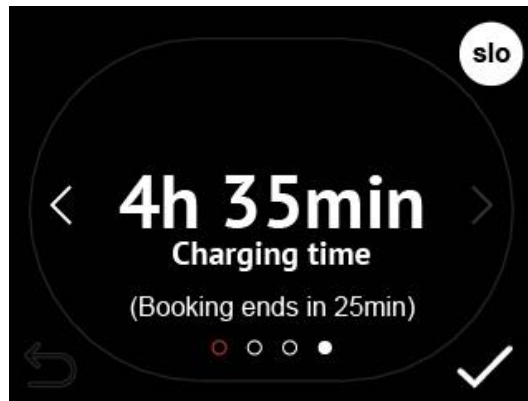

Figure 20: Display of charging time

### CHECK STATUS OF THE CHARGING STATION

In the web interface the information of the current session can be seen. The departure time can be changed using web interface by pressing the »Interactive mode« button.

### STOP THE CHARGING SESSION

Charging station can be stopped locally or remotely.

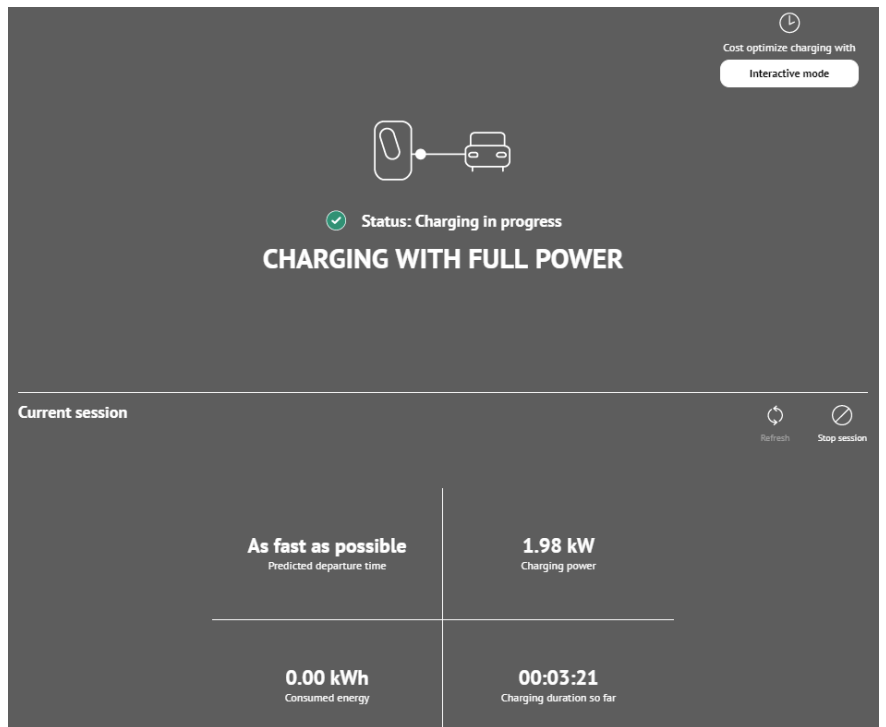

Figure 21: Display of current data on web interface

### LOCALLY

The charging session can be ended by using the same authorization method as for starting the session (using an RFID card, mobile application, PIN code) and removing the plug from the charging socket or, in the case of a station configuration without authorization, by simply removing the plug from the charging socket.

### REMOTELY

Stop of charging session can be done remotely with the use of web interface. The previous figure shows the Stop Session button. When this button is pressed, a confirmation message is displayed. After confirmation, charging is interrupted. In the same way, a charging session can be ended using a mobile application.

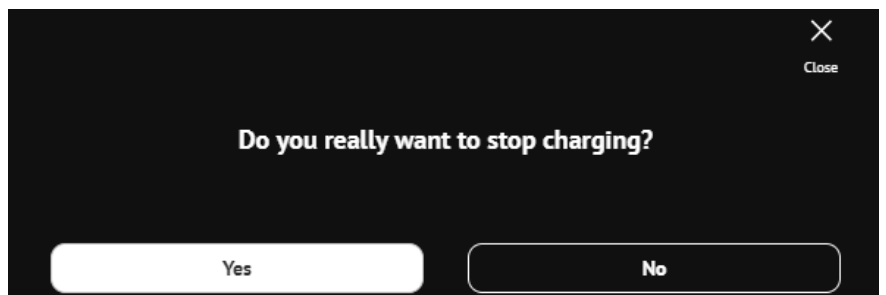

Figure 22: Confirmation window on the network interface to complete charging

## 4

## CHARGING STATION WEB INTERFACE

Charging station's web interface allows the connection to the charging station platform, configuration of its settings as well as check of the charging session and station data, check of the connectivity status and errors description when they occur.

- WiFi network name must not contain "-".
- WiFi communication must be disabled (if using ethernet).

### CONNECT TO WEB INTERFACE

Users can connect to the charging station web interface using the charging station IP address. Default IP address can be found on the information sticker on the inner part of the maintenance doors. IP address of the charging station can be manually changed.

When IP was changed and forgotten, it can be obtained with pressing for several seconds on the "three dots" on the display. IP can also be obtained with pressing the reset key for several seconds.

When IP address is written in the internet browser and the computer is in the same local network, the charging station will be connected to the web interface.



Figure 23: Insert the default IP into the browser to connect to web interface

### PING CHARGING STATION FROM COMPUTER IN SAME NETWORK

#### WINDOWS

To determine if the computer is in the same network as charging station ping the station using the CMD command ping with the IP of the station. Computer network can be changed in the network settings.

To ping the station, connect to Command Prompt by searching for it in windows search functionality.

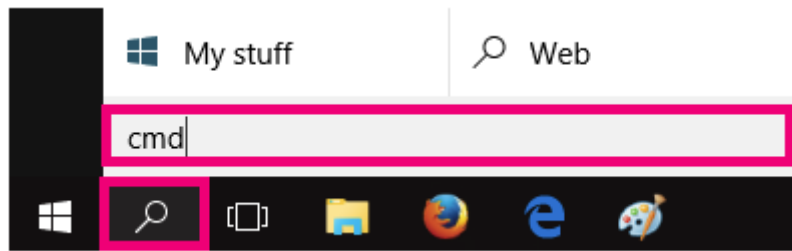

Figure 24: Search for CMD using Windows Search

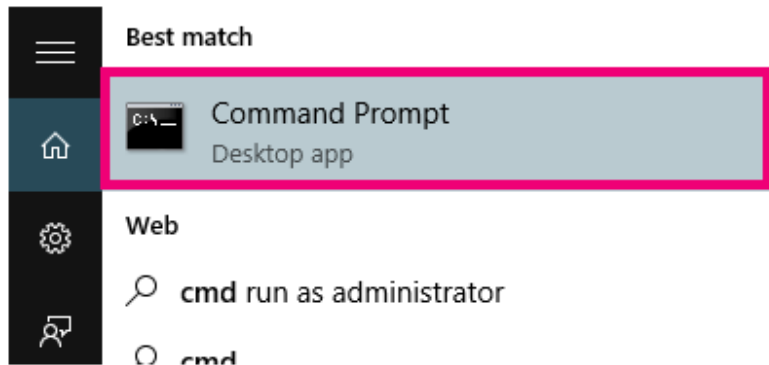

Figure 25: Open Command Prompt

In the Command Prompt write “ping” and IP address (e.g., ping 192.168.1.190).

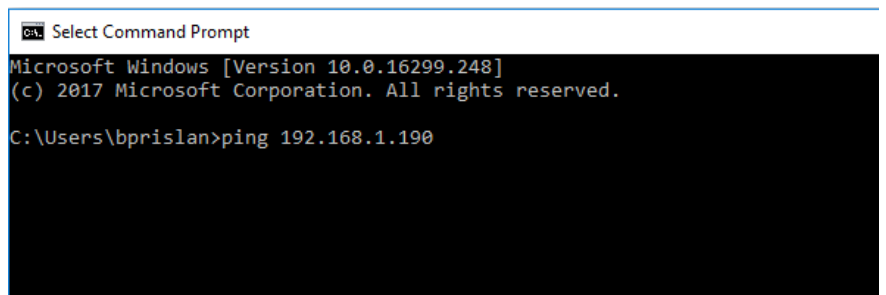

Figure 26: Ping the charging station IP address

If the ping is not successful, the computer might be in different network segment. In this case it, the segment need to be changed in network settings to the one of the charging stations.

### APPLE COMPUTER

When using apple computers, pinging of the station can be performed using Terminal. It can be accessed by going to the “Applications” and selecting “Utilities”. Search for “Terminal” and run it.

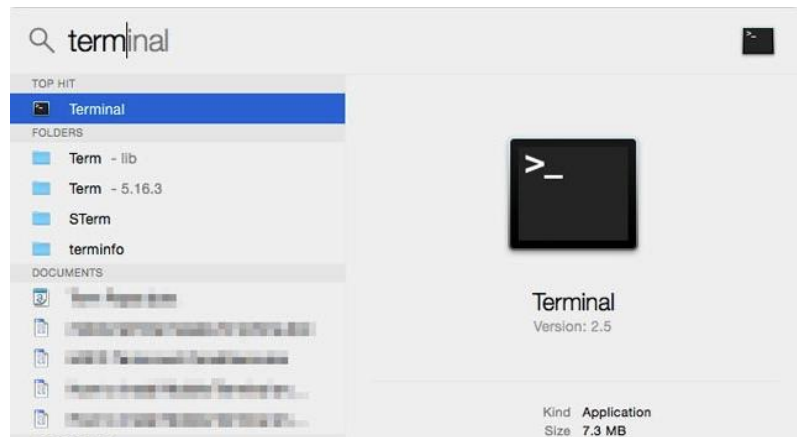

Figure 27: Run Terminal software

When Terminal is running, write ping and IP (e.g., ping 192.168.1.250).

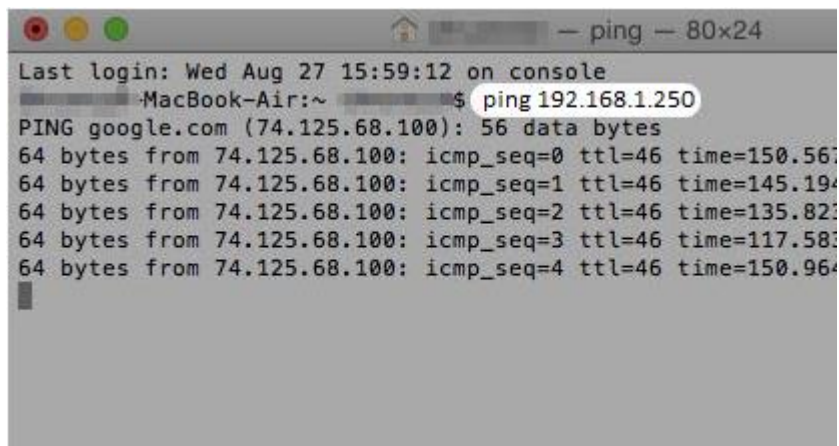

Figure 28: Ping charging station by writing ping and charging station's IP

## CHANGE THE COMPUTER NETWORK SETTINGS

If pinging of the charging station is not working, also the connection to the charging station's web interface will not work. To configure the charging station, the network settings will need to be changed. Either configure new IP for the selected interface (Advanced, Add), or change the computer's IP.

## WINDOWS

To change the network of the computer in Windows OS, network settings in the Control panel need to be located. First, open the Control panel with click on the icon or searching in the Start menu.

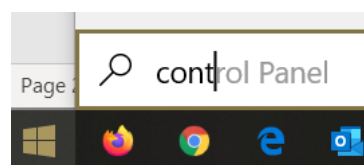

Figure 29: Search for Control Panel using Windows Search

First select “Network and Internet” and then “Network Connections”. Depending on the version of the Windows operation system, instead of “Network Connection”, the option “Network and Sharing Centre” could also be the right one.

Click on the Ethernet Connection that is being used.

In the Internet protocol Version 4 (TCP/IPv4), “Properties” need to be selected and this will show a new window where the new IP address of the computer that is in the same network segment as the station’s IP can be written.

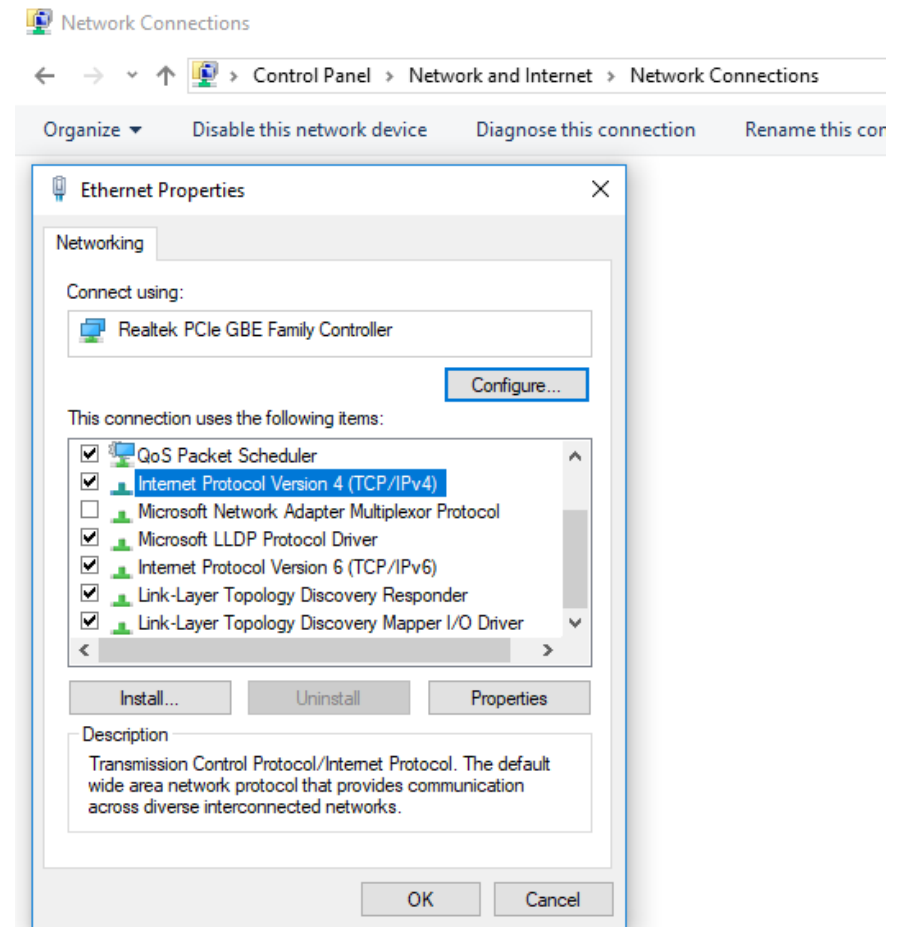

Figure 30: Locate Internet Protocol Version 4(TCP/IPv4) in network properties

If the station default IP is 192.168.1.250 the computer IP address should be changed to **192.168.1.1**.

Last bolded number can be a random number as long as it is different than 250 (used by station) and is not used by any other appliance in the network. In many cases, the number 1 is already taken by the router and other numbers can be used by other computers. The IP address that we set to the computer must be unique for that network.

Set subnet mask to 255.255.255.0. and the pinging should work.



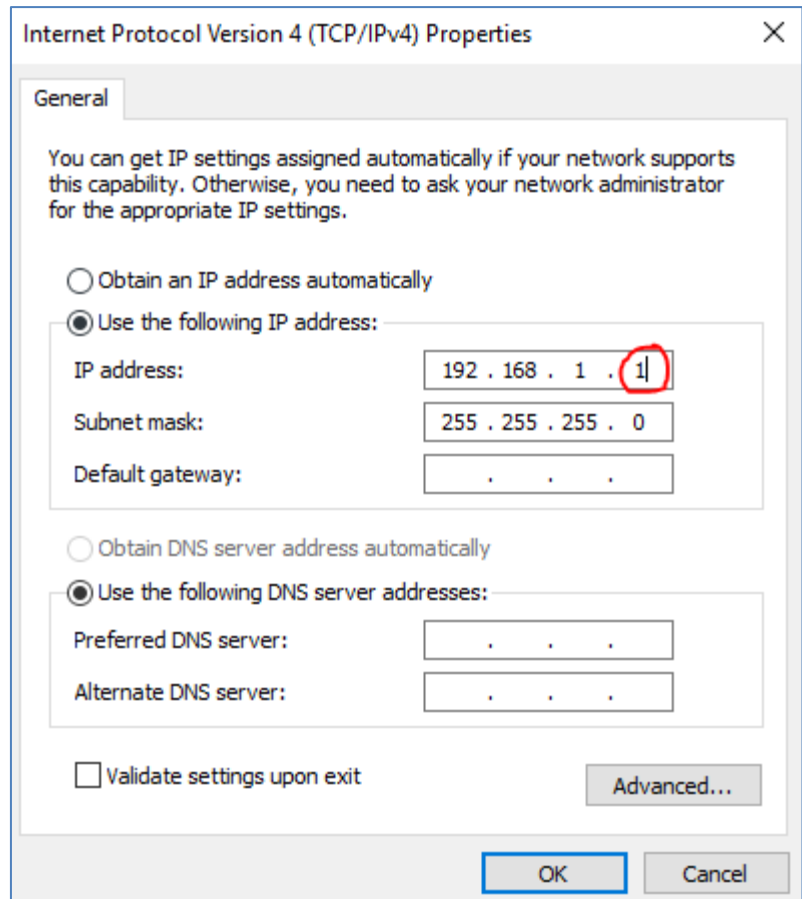

Figure 31: Change the IP of the computer and subnet mask

### APPLE COMPUTER

To change the IP settings of Apple computer, the »Apple« button need to be pressed to access the »System preferences«



Figure 32: Locate System Preferences

Click the Network icon.



Figure 33: Click Network icon

Click on the Wi-Fi or Ethernet connection (Depends on which one is used) and press Advanced button in the bottom right.



Figure 34: Go to advanced settings of internet connection

Choose TCP/IP. In the Configure IPv4 option choose Manual and change IPv4 Address to 192.168.1.1. Last bolded number can be a random number as long as it is different than 250 (used by station) and is not used by any other appliance in the network. Set subnet mask to 255.255.255.0. and the pinging should work.

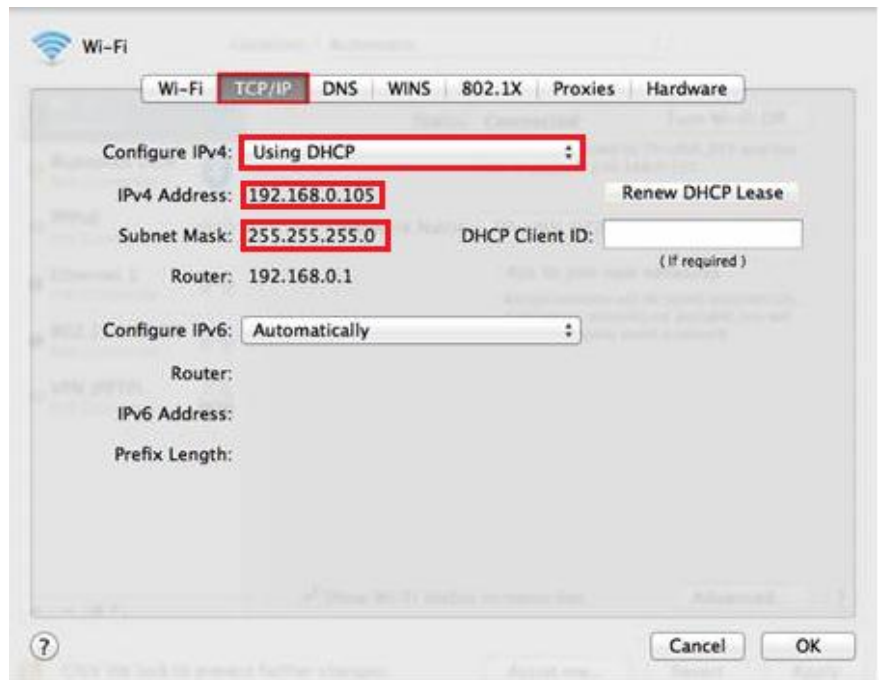

Figure 35: Set network settings

## USING DHCP FOR CONNECTION

When DHCP is used router automatically assigns IP address to the charging station connected to it. To acquire DHCP address the charging station reset button need to be pressed for 4 s until the first beep sound is heard. Address will be displayed on the LCD screen.

## USING WEB INTERFACE

In the web interface each type of user has different rights what he can see and edit in the web interface. Operators will have the highest rights to set up all the configuration and connectivity settings. A regular home user only has basic rights that will allow him to see Dashboard and Diagnostics module.

## MAIN DASHBOARD

Main dashboard window allows to see current power, cluster power if the charging station is part of the cluster, building power load, charging station availability and information about the last session.

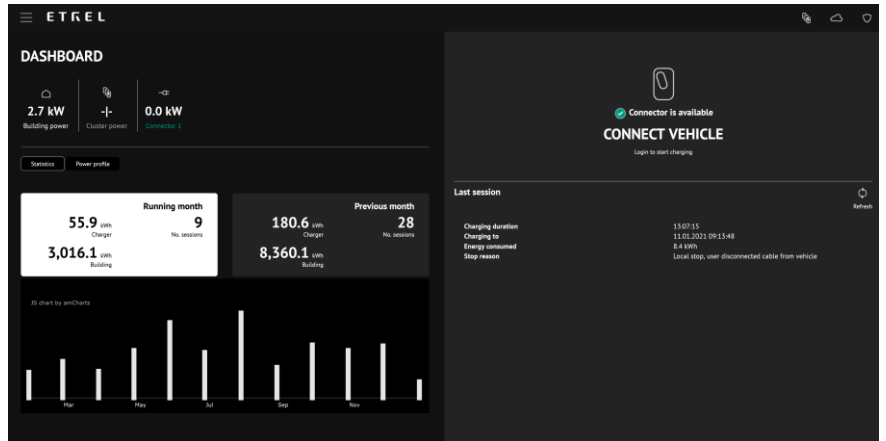

Figure 36: Web interface main Dashboard view

Last session status will be shown on the screen right. If anything went wrong during the session, additional information can be acquired in the Diagnostics menu.

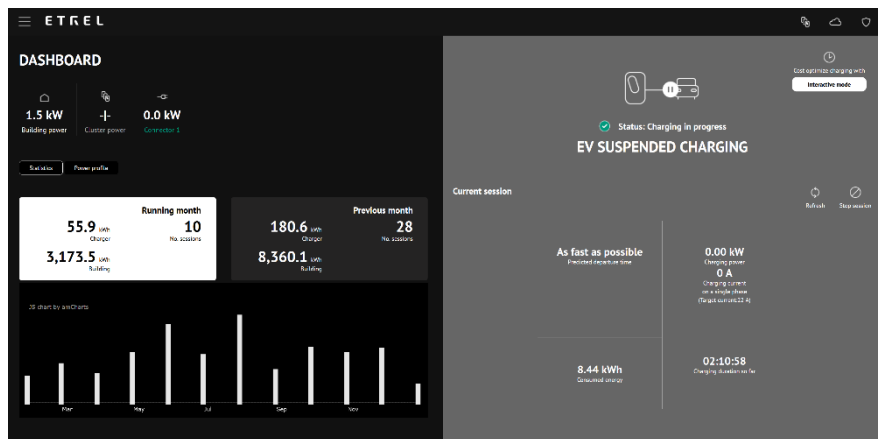

Figure 37: Current session information displayed in the web interface

On the picture above, the button “Stop session” is shown. When pressing this button new window will pop up to confirm the action. After that the session will stop.

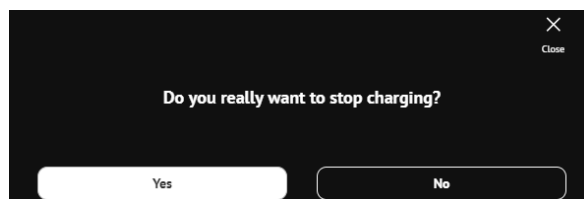

Figure 38: Confirmation window to stop the charging session using web interface

## DIAGNOSTICS

When experiencing problems, the logs can be downloaded from “Diagnostic” menu and then sent to the operator to check what is wrong with charging station. Basic information about the charging station are also in the Diagnostics menu.

Basic information:

- Model,
- Serial number,
- Hardware version,
- Software version,
- Connector controller hardware version,
- Connector controller driver version and
- Connector controller firmware version.

“Diagnostic” module can also be used to upgrade firmware, restore data and backup charging session data, and reset charging station remotely.

Backup configuration gives operator option to restore charging station to the same configuration if something malfunctions with the system and charging station needs to be restored to default settings.

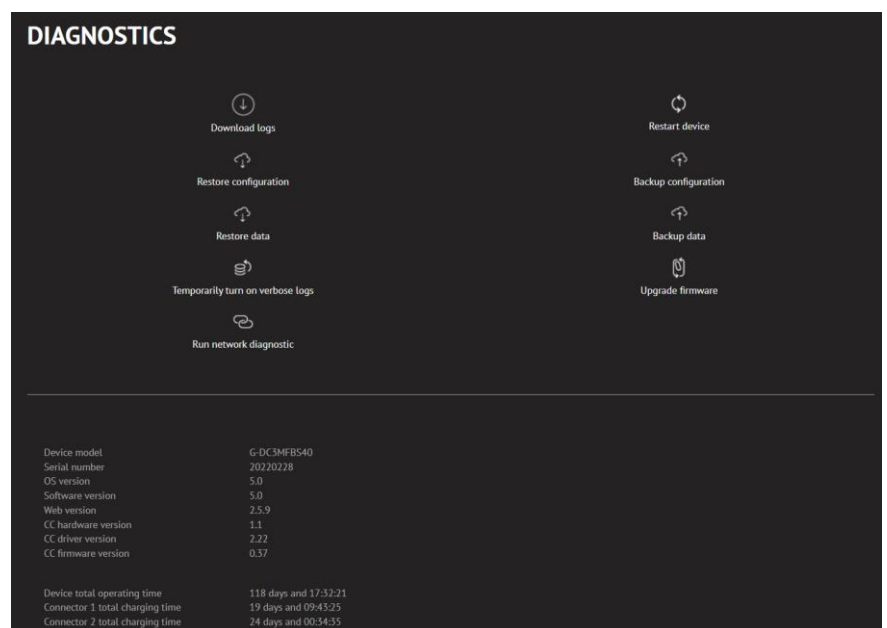

Figure 39: Diagnostics web interface module

## CHANGE THE WEB INTERFACE LANGUAGE

The language of web interface can be changed by pressing the burger menu and selecting the language at the bottom left corner. Only languages supported by web interface are available.

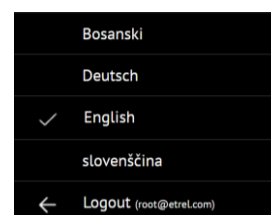

Figure 40: Menu with the language choices

More information about the web interface can be found in the INCH Configuration guide.

## 5

# REGULAR MAINTENANCE

It is recommended to perform a visual check and test of the protection elements at least once per year if local regulations do not state otherwise. It is possible that the requirement is to check more often, e.g., every three months, or every month. The check should also be documented.

## CLEANING

- Use cloth and water or water-based or alcohol-based cleaners.
- Do not use solvent-based cleaners.

## ACCESS TO THE MAINTENANCE AREA

Etreel INCH charging station provides quick access to the side maintenance area to execute basic maintenance and troubleshooting.

Side maintenance area is protected by the side maintenance doors. Depending on the type of Etreel INCH charging station, two different doors are available. One with the regular key lock and one with hex screw (2.5 mm). To access the area, either key or a hex screwdriver is needed.



Figure 41: Doors with keylock



Figure 42: Doors with hex screw

There is a sticker on the inside of maintenance doors, with technical information including basic charging station information, model type and serial number. When support is contacted it is important that the charging station model type is known so the support can quickly help solve the issue. This information can also be gathered on the web interface in the Diagnostics menu.

## **GENERAL INSPECTION OF THE STATION**

It is recommended to perform a visual check of the charging station and test of the protection elements at least once per year if local regulations do not state otherwise. It is possible that the requirement is to check more often, e.g., every three months, or every month. The check should also be documented.

Recommended procedure:

- Examine every socket for potential damage. Access to the sockets must always be enabled and any foreign objects that might be lodged in must be removed as soon as possible.
- Examine the casing of the charging station for potential damage.
- Check the protection elements, as described in the following chapter.

If during the check any problems or malfunctions are detected, call licensed electrician or maintenance service team.

## **CHECK THE PROTECTION ELEMENTS**

Protection elements can be part of charging station, or they can be installed in the upstream installation. They should be regularly checked no matter the location.

### **OVERCURRENT PROTECTION**

Check the overcurrent protection once a year for any visible damages on the surface. If the overcurrent protection is tripped and the switches cannot return to the active position something is wrong with the protection and needs to be changed by maintenance crew.

### **SURGE AND OVERVOLTAGE PROTECTION**

Check the surge and overvoltage protection (if installed) once a year for any visible damages on the surface. If the surge and overvoltage protection is tripped it needs to be changed by the maintenance crew. This protection should be installed in any case.

### **RCD**

The regulations require that residual current protective device (RCD) is tested regularly, and an audit log should also be kept. The test button on the RCD unit allows user to verify the correct operation of the device by passing a small current through the RCD unit. This simulates a fault by creating an imbalance in the sense coil. If the RCD does not trip when

this button is pressed, then the device must be replaced by licensed electrician. The device must be changed also when the RCD was tripped but the switch cannot be moved back into active position.



Figure 43: RCD test button



# 6

## TROUBLESHOOTING

In the table below, all possible events that can occur at the power up of the station are listed with the procedure what to do in case something is wrong.

STATUS LIGHT	NORMAL OPERATION	PROBLEM	SOLUTION
<b>Fast blinking green light</b>	<p>Charging station's backup batteries are charging.</p> <p>At the first power up it can take up to 10 min.</p> <p>If backup battery is full, green light will blink slowly.</p>	<p>If the light is blinking fast more than 10 min there might be a problem with the backup battery.</p>	<p>Inform the support about the status of the charging station.</p>
<b>Slowly blinking green light</b>	<p>LCD screen is preparing to turn on. Heating system is trying to heat the LCD before it is turned ON.</p>	<p>If the green light is blinking slowly for more than 10 minutes and the LCD has not been turned on, there might be a problem with the LCD.</p>	<p>Support should be called.</p>
<b>Steady glowing green light</b>	<p>Charging station is ready to be used.</p>	/	/
<b>No lights</b>	/	<p>If charging station is not responding after it is powered up, something might be wrong with power connection.</p>	<p>Check the protection elements if either RCD or overcurrent protection has been tripped.</p> <p>Activate the protection.</p> <p>If nothing helps call the support or installer.</p>

<p><b>Green light is blinking</b></p>	<p>LCD is turned on and charging station is ready to be used.</p> <p>When the LCD starts the logo will be first displayed and after that the charging station can be used.</p>	<p>LCD is turned on but freezes and is unresponsive.</p>	<p>Try resetting the charging station. If the problem repeats there might be a problem with the software.</p> <p>Support should be called.</p>
---------------------------------------	--	--	--

**Errors dangerous to device users:**

Dangerous voltage present on enclosure or device under fire. In this case the device should be turned off immediately. Switch off device power supply of device in the distribution board from where device is supplied and not on device itself. Do not touch device.

If vehicle is connected at that moment, disconnect plug from the vehicle and not from the charging station, but only after the power supply was switched off. In the case of fire use fire extinguisher appropriate for electrical fire.

**Faults occurred because of external conditions:**

Undervoltage, overvoltage, short and long power supply outages, or wrong vehicle behaviour. In these cases, no action is needed to re-establish normal operating conditions.

Once fault is gone, normal operation conditions will be established automatically. If temporary fault was caused by vehicle, user will have to reinitiate charging session.

**Device hardware failure preventing normal operation:**

Example: Broken socket, broken LCD, electronics failure. If after restart device does not start normally, contact supplier support.

**Charging station software failure:**

Check that latest version of firmware is running on the charging station. If the latest version is installed and problem persist, then check if problem is caused by the charged vehicle. To check this, the charging could be tried on another charging station. If problem is not in the vehicle send diagnostic logs to the supplier.

**The web interface of the charging station can also be used for troubleshooting.**

## **RESETTING THE CHARGING STATION**

Charging station can be reset by opening the side maintenance doors and pressing the button inside the maintenance opening.

After holding the button for 4 s, the charging station will respond with the beep after which the options on the screen to check the IP address of the station or to reset the station will be presented.

Basic reset and factory reset, which will restore charging station's factory settings (username, password, default IP and other settings) can be made.



Figure 44: Reset button inside the maintenance opening

The reset of the charging station can be made from the web interface as well.

# 7

## CONTACT INFORMATION

### TECHNICAL SUPPORT DEPARTMENT

e-mail: [support@etrel.com](mailto:support@etrel.com)

phone: +386 1 601 0127

### CUSTOMER SUPPORT DEPARTMENT

e-mail: [sales@etrel.com](mailto:sales@etrel.com)

phone: +386 1 601 0175

### AUTHORISED SERVICE CENTRES

e-mail: [support@etrel.com](mailto:support@etrel.com)

phone: +386 1 601 0075

**Etrel d.o.o.**

**Pod jelšami 6**

**1290 Grosuplje**

**Slovenia**

**EU**

**[www.etrel.si](http://www.etrel.si)**