

1

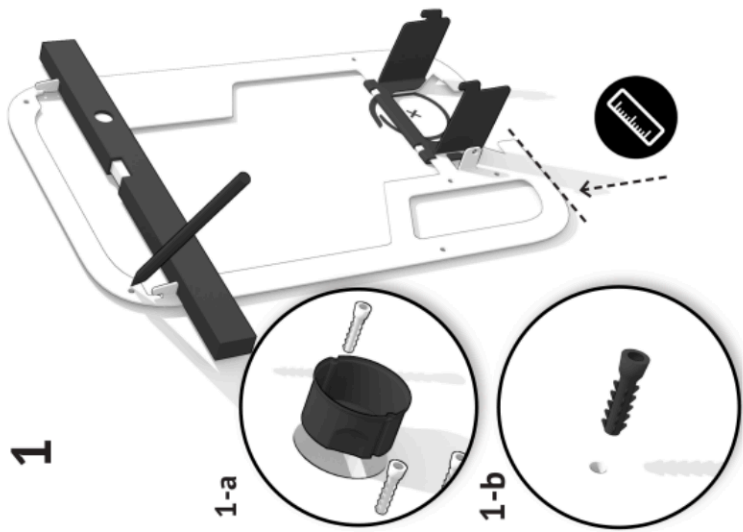

A2

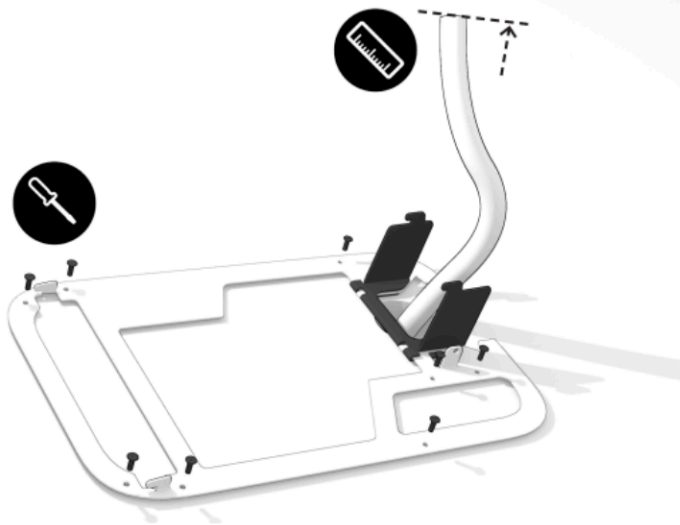

3

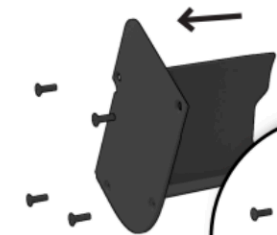

3-a

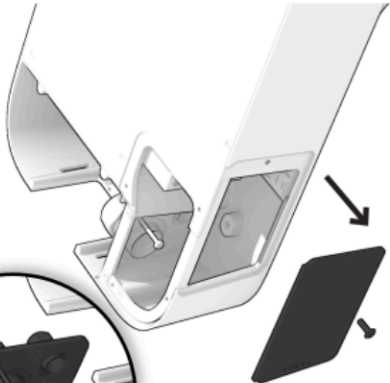

B2

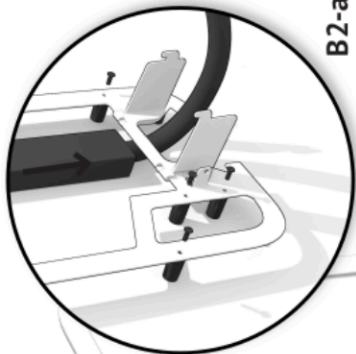

B2-a

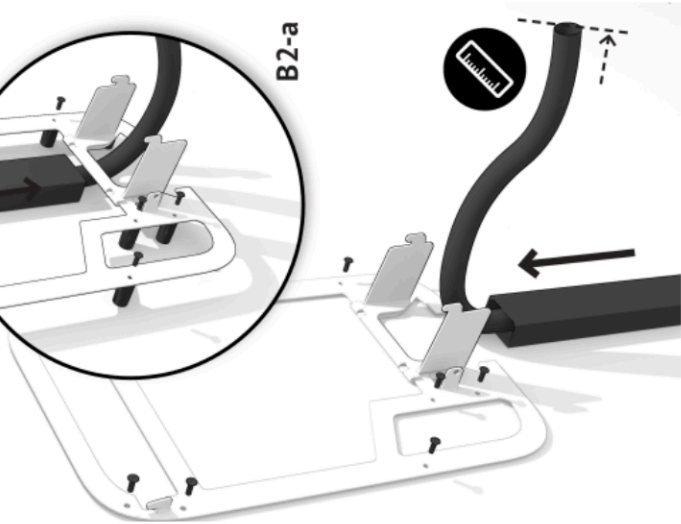

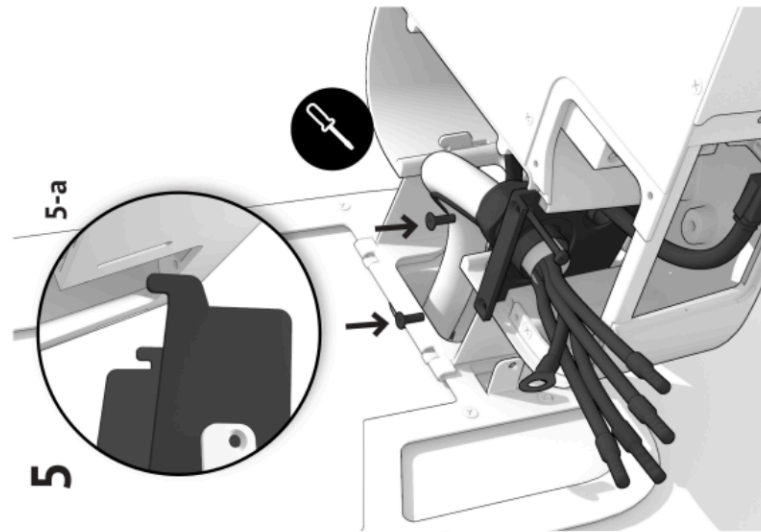
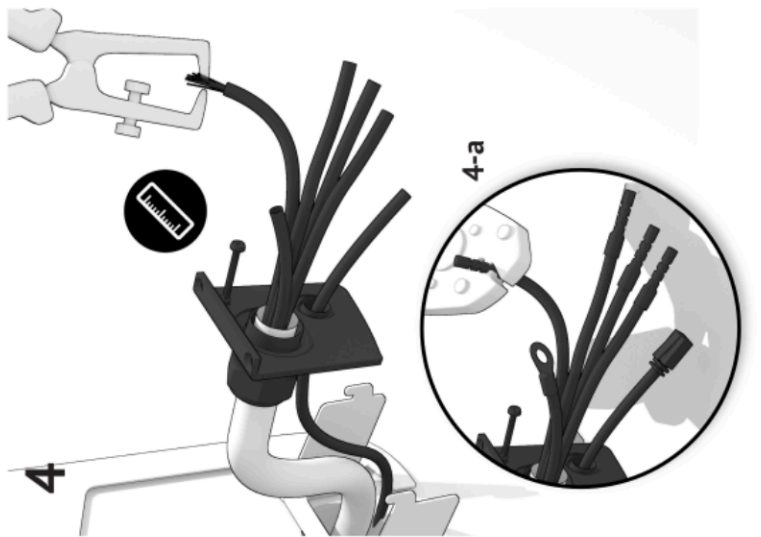

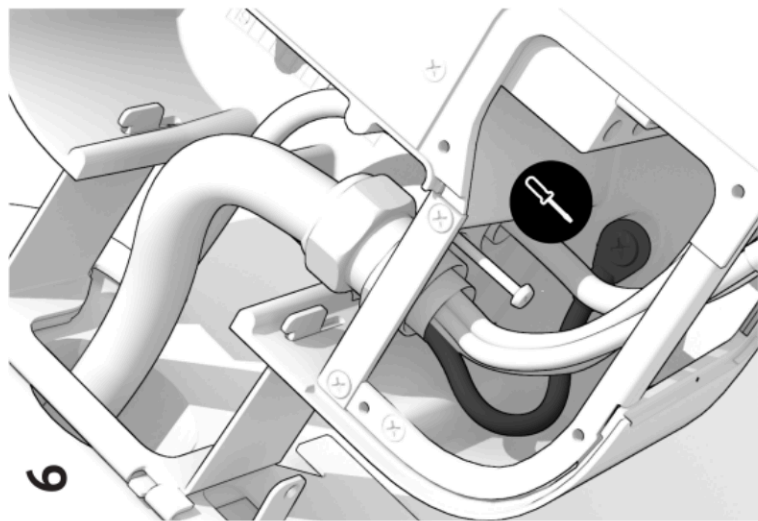
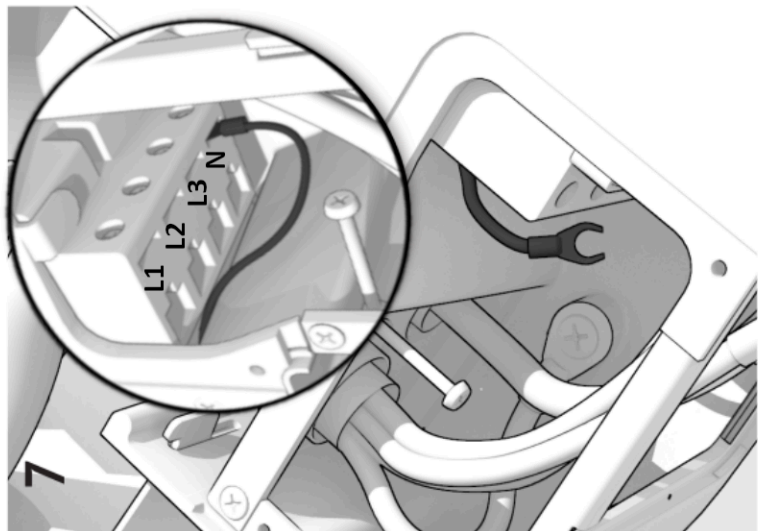

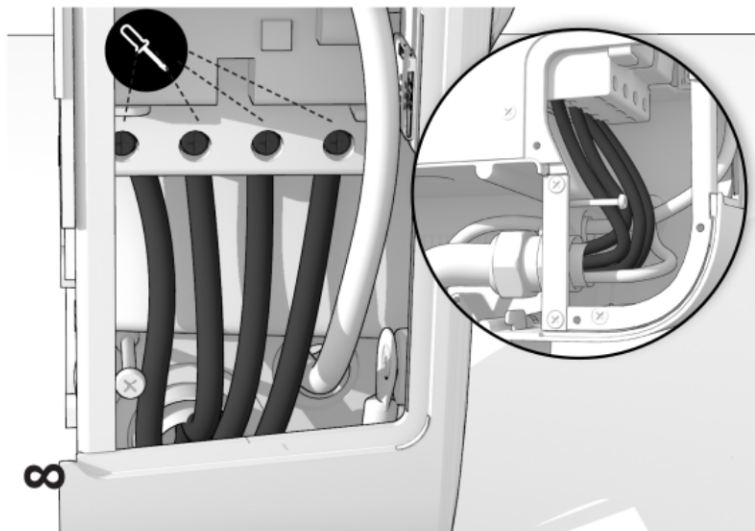
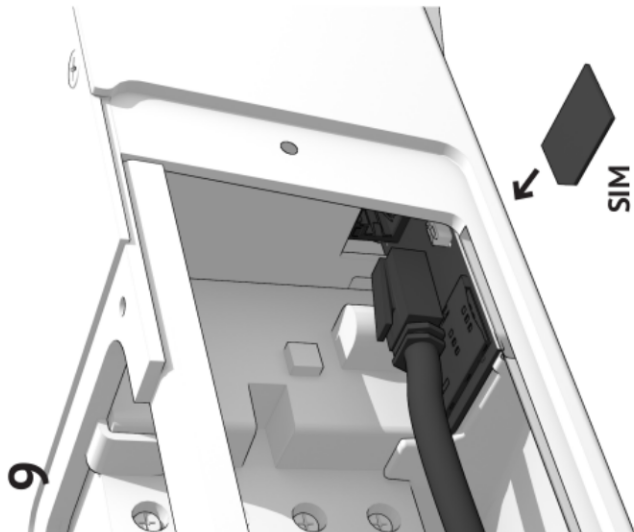

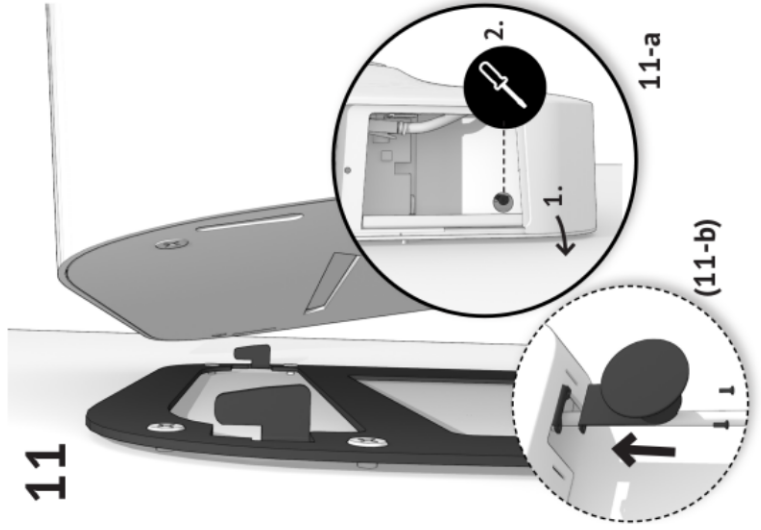
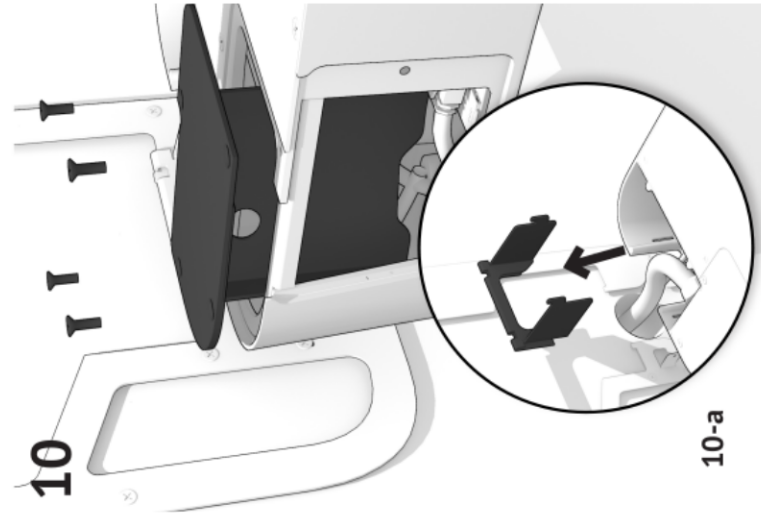

12

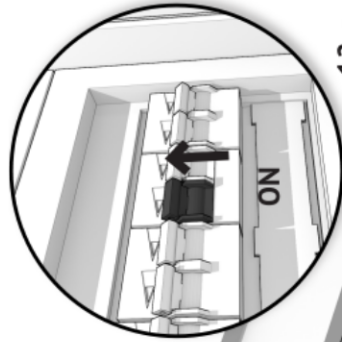

13

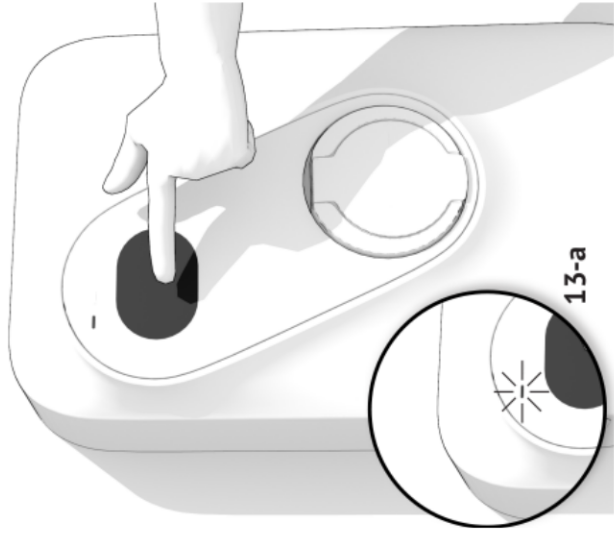

(14)

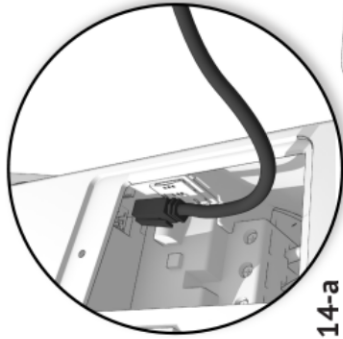

14-a

